

CATÁLOGO / CATALOGUE 2022-2023



MOBILIARIO URBANO | SEÑALIZACIÓN VIAL
URBAN FURNITURE | ROAD SIGNALIZATION

LA EMPRESA / THE COMPANY

Disponemos de una gran variedad de productos dentro del sector del mobiliario urbano. Como fabricantes, diseñamos nuestros productos y los personalizamos según las necesidades del cliente. Con más de 45 años de experiencia en el sector, estamos especializados en mobiliario urbano, señalización vial, automatismos, vallados, cerrajería, trabajos con aluminio, hierro, acero inoxidable, acero corten, etc. Nuestro objetivo, ser referente en productos de calidad dentro del sector. Ofrecemos productos innovadores y fabricación a medida.

We offer a wide range of products within the urban furniture sector. As manufacturers, we design our own products giving to our clients the possibility to customize them, according to their specific requirements. 45 years of experience in this sector, we are now specialized in the manufacturing of urban furniture, road signs, automatismos, fencing, locksmithing, items in aluminium, iron, stainless steel, corten steel, etc. Our mission is to become a benchmark of quality in the urban furniture sector. We offer innovative and customizable products, different from anything else available on the market.

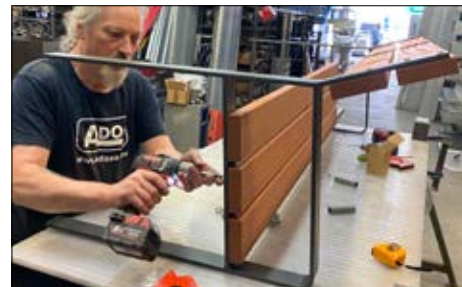

OFICINA Y FÁBRICA HEADQUARTER AND FACTORY



C/ Acer, 37 al 43
Polígono Industrial Les Guixeres.
08915 Badalona.



+34 93 456 03 03



+34 93 116 29 75



Como llegar
How to arrive



ALMACÉN LOGÍSTICO LOGISTIC STORAGE



C/ Camí del Crist
Polígono Industrial 2. Parcela 5.
08340 Vilassar de Mar.



+34 93 395 79 17



Como llegar
How to arrive



CATEGORÍAS ESPECIALES / SPECIAL CATEGORIES



Todos los productos marcados con este icono están diseñados y fabricados por ADO en España.
All the products branded with this logo are designed and manufactured by ADO, in Spain.



Disponemos de una categoría especial en la que incluimos productos de diseño a precio competitivo que irán marcados con el logo.
Design products available at competitive prices are classified in a special product range, marked with the logo.

Los colores / acabados de los productos son orientativos y pueden sufrir alguna alteración debido a la impresión.
The colors / finishes of the products are approximate and may suffer some alteration due to printing.

ÍNDICE / INDEX



Escanear código QR ver en web / Scan the QR code to see on web



Ver todos los modelos en la web / See all models on the web



PILONAS FLEXIBLES

FLEXIBLE BOLLARDS

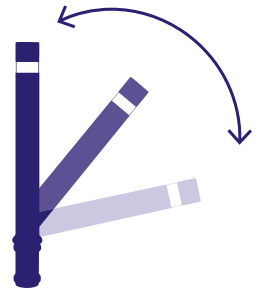

A-FLEX



PLÁSTICO POLIURETANO | POLYURETHANE PLASTIC



PFLEXHN

PFLEXHN

PFLEXHNP

+
BEXTRAP01



Colores estándar
Standard colors

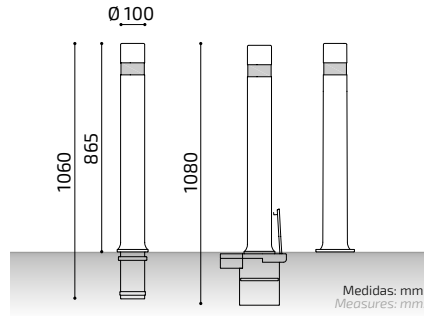

Medidas: mm.
Measures: mm.



Flexibilidad 90°.
Flexibility 90°.



Opcional base con placa reforzada.
Optional base with reinforced plate.



Cinta reflectante amarilla.
Yellow reflective tape.

MODELO PATENTADO
PATENTED MODEL



A-FLEX DT



PLÁSTICO POLIURETANO | POLYURETHANE PLASTIC



PFLEXDTHN

PFLEXDTHN

PFLEXDTHNP

+
BEXTRAP01

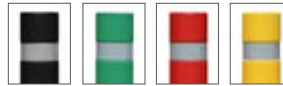

Colores estándar
Standard colors

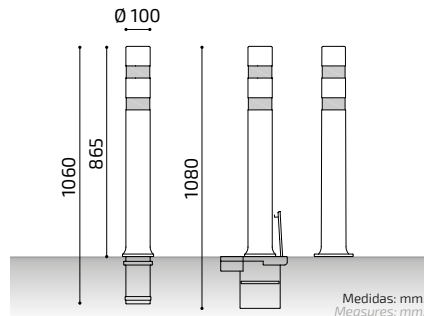

Medidas: mm.
Measures: mm.



Flexibilidad 90°.
Flexibility 90°.



Opcional base con placa reforzada.
Optional base with reinforced plate.



Cinta reflectante amarilla.
Yellow reflective tape.

MODELO PATENTADO
PATENTED MODEL



A-FLEX DT CARRIL BICI / A-FLEX DT FOR BICYCLE LANE



PLÁSTICO POLIURETANO | POLYURETHANE PLASTIC



PFLEXDTHG

PFLEXDTHG

PFLEXDTHGP

+
BEXTRAP01



Pilona homologada
Homologated bollard

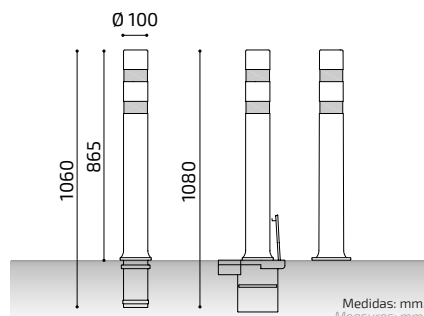

Medidas: mm.
Measures: mm.



Flexibilidad 90°.
Flexibility 90°.



Opcional base con placa reforzada.
Optional base with reinforced plate.



Cinta reflectante amarilla.
Yellow reflective tape.

MODELO PATENTADO
PATENTED MODEL



A-FLEX 80

PLÁSTICO POLIURETANO | POLYURETHANE PLASTIC

MODELO PATENTADO
PATENTED MODEL



Colores estándar
Standard colors

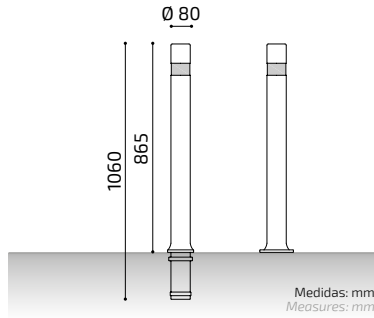

Medidas: mm.
Measures: mm.



 Flexibilidad 90°.
Flexibility 90°.

 Opcional base con placa reforzada.
Optional base with reinforced plate.

 Cinta reflectante amarilla.
Yellow reflective tape.

A-FLEX DT 80

PLÁSTICO POLIURETANO | POLYURETHANE PLASTIC

MODELO PATENTADO
PATENTED MODEL



Colores estándar
Standard colors

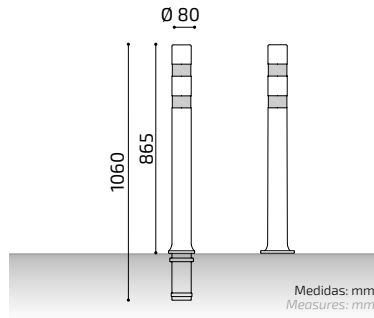

Medidas: mm.
Measures: mm.



 Flexibilidad 90°.
Flexibility 90°.

 Opcional base con placa reforzada.
Optional base with reinforced plate.

 Cinta reflectante amarilla.
Yellow reflective tape.

A-FLEX BADALONA

PLÁSTICO POLIURETANO | POLYURETHANE PLASTIC

MODELO PATENTADO
PATENTED MODEL

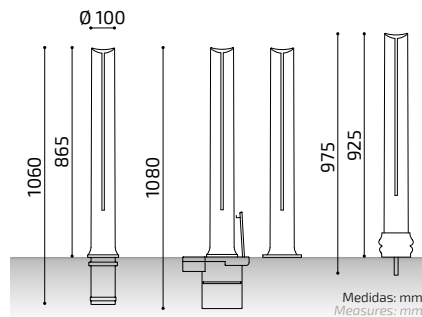

Medidas: mm.
Measures: mm.



 Flexibilidad 90°.
Flexibility 90°.

 Opcional base con placa reforzada.
Optional base with reinforced plate.

A-FLEX SANT FELIU

PLÁSTICO POLIURETANO | POLYURETHANE PLASTIC



PFSFHN

PFSFHN

PFSFHNP

PFSFHNT

+ **BEXTRAPO1**

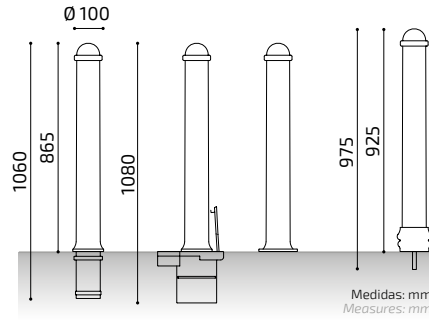

Medidas: mm.
Measures: mm.



Flexibilidad 90°.
Flexibility 90°.



Opcional base con placa reforzada.
Optional base with reinforced plate.

MODELO PATENTADO
PATENTED MODEL



A-FLEX AGBA

PLÁSTICO POLIURETANO | POLYURETHANE PLASTIC



PFAGBAHN

PFAGBAHN

PFAGBAHNP

PFAGBAHNT

+ **BEXTRAPO1**

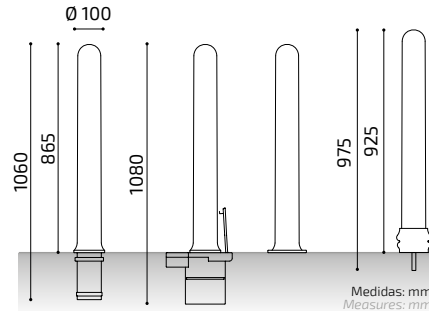

Medidas: mm.
Measures: mm.



Flexibilidad 90°.
Flexibility 90°.



Opcional base con placa reforzada.
Optional base with reinforced plate.

MODELO PATENTADO
PATENTED MODEL



A-FLEX FORUM

PLÁSTICO POLIURETANO | POLYURETHANE PLASTIC



PFFORUMHN

PFFORUMHN

PFFORUMHNP

PFFORUMHNT

+ **BEXTRAPO1**

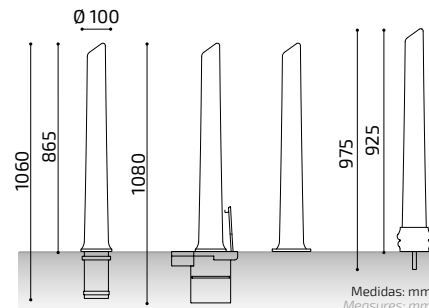

Medidas: mm.
Measures: mm.



Flexibilidad 90°.
Flexibility 90°.



Opcional base con placa reforzada.
Optional base with reinforced plate.

MODELO PATENTADO
PATENTED MODEL



¡NOVEDAD!

PILONAS FLEXIBLES
A-BLEN CON TORNILLO

NEW!
*FLEXIBLE BOLLARDS
A-BLEN WITH SCREW*

✓ Fácil y rápida instalación.
Roscar tornillo al pavimento.
*Easy and fast installation.
Thread screw to the pavement.*

✓ Reducido coste de instalación.
Reduced installation cost.



Opcional: Llave fijación.
Optional: Key to fix the bollard.



Ø 100

Ø 80

Ø 100

CARRIL BICI
FOR BICYCLE LANE





A-BLEN



PLÁSTICO POLIURETANO | POLYURETHANE PLASTIC



Pilona flexible diseñada para la señalización vial, ideal para carreteras, carriles de bicicletas y parkings. Pilona muy resistente, después de un impacto recupera su forma original.

Flexible bollard designed for road signalization; can be used in roads; bike lanes and parkings. Excellent impact resistance; in case of impact it returns to its original shape and position.

A-BLEN



PLÁSTICO POLIURETANO | POLYURETHANE PLASTIC



Detalle superior.
Cap detail.



Colores estándar
Standard colors



Opcional: Llave fijación.
Optional: Key to fix the bollard.

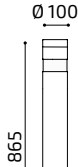

Medidas: mm.
Measures: mm.

PBLENN

LLFLEXT



Flexibilidad 90°.
Flexibility 90°.



Cinta reflectante amarilla.
Yellow reflective tape.

A-BLEN DT



PLÁSTICO POLIURETANO | POLYURETHANE PLASTIC



Detalle superior.
Cap detail.



Colores estándar
Standard colors



Opcional: Llave fijación.
Optional: Key to fix the bollard.

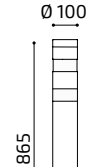

Medidas: mm.
Measures: mm.

PBLENDTN

LLFLEXT



Flexibilidad 90°.
Flexibility 90°.



Cinta reflectante amarilla.
Yellow reflective tape.

A-BLEN DT CARRIL BICI A-BLEN DT FOR BICYCLE LANE



PLÁSTICO POLIURETANO | POLYURETHANE PLASTIC



Detalle superior.
Cap detail.



Opcional: Llave fijación.
Optional: Key to fix the bollard.

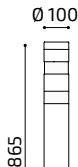

Medidas: mm.
Measures: mm.

PBLENDTG

LLFLEXT



Flexibilidad 90°.
Flexibility 90°.



Cinta reflectante amarilla.
Yellow reflective tape.

A-BLEN TT



PLÁSTICO POLIURETANO | POLYURETHANE PLASTIC



Detalle superior.
Cap detail.



Colores estándar
Standard colors



Opcional: Llave fijación.
Optional: Key to fix the bollard.

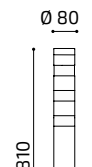

Medidas: mm.
Measures: mm.

PBLENTT80N

LLFLEXT



Flexibilidad 90°.
Flexibility 90°.



Cinta reflectante amarilla.
Yellow reflective tape.



PILONAS LUMINOSAS CON LED FLEXIBLES Y SEMIFLEXIBLES

FLEXIBLE AND SEMI FLEXIBLE LED LIGHT BOLLARDS



Pilona flexible luminosa con led en la parte superior pudiendo elegir color de led blanco ó led rojo, Otros colores y configuraciones a consultar (leds RGB), programación horaria, ...

Flexible light bollard with led on the top led color can be chosen between white and red. Other colors, settings (leds RGB) and time scheduling to be consulted.

A-FLEX LEDS

PLÁSTICO POLIURETANO | POLYURETHANE PLASTIC



PFLEXHNL **PFLEXHNL**
+ **BEXTRAP01** **PFLEXHNPL**



Leds / Leds

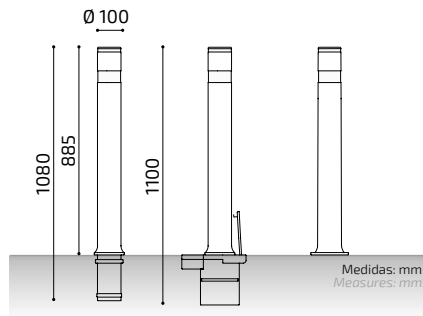

Flexibilidad 90°. Flexibility 90°.



Posibilidad doble tira. Double strip possibility.



Bajo consumo 12v. Low-energy 12v.

A-ECO LEDS

PLÁSTICO POLIPROPILENO | POLYPROPYLENE PLASTIC



PECOHN **PECOHN**
+ **BEXTRAP01** **PECOHNPL**



Leds / Leds

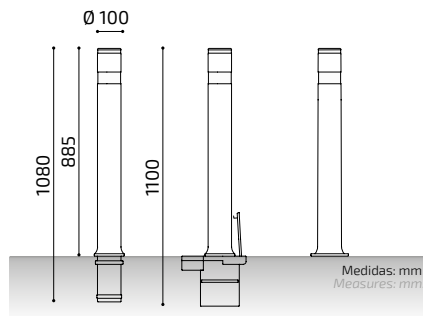

Flexibilidad limitada. Limited flexibility.



Posibilidad doble tira. Double strip possibility.



Bajo consumo 12v. Low-energy 12v.



Escanear código QR ver en web / Scan the QR code to see on web



Ver todos los modelos en la web / See all models on the web



PILONAS SEMIFLEXIBLES HITOS FLEXIBLES

SEMIFLEXIBLE BOLLARDS
ROAD DELINEATORS

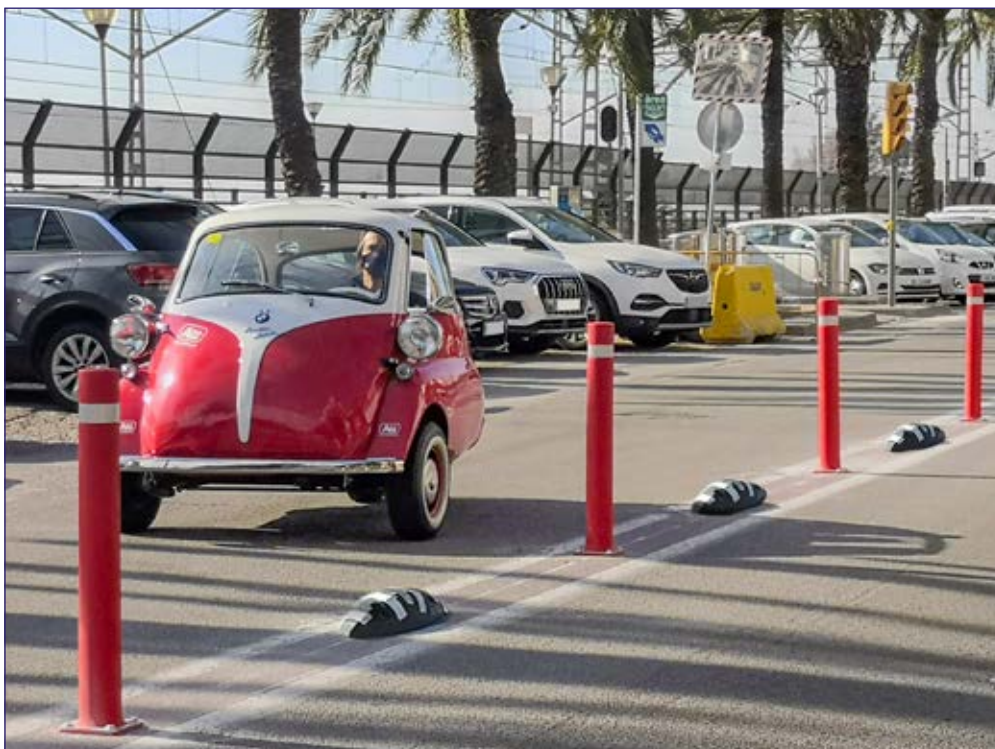

A-ECO

PLÁSTICO POLIPROPILENO | POLYPROPYLENE PLASTIC



PECHN **PECHN**
+
BEXTRAP01 **PECHNP**

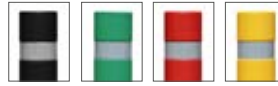

Colores estándar
Standard colors

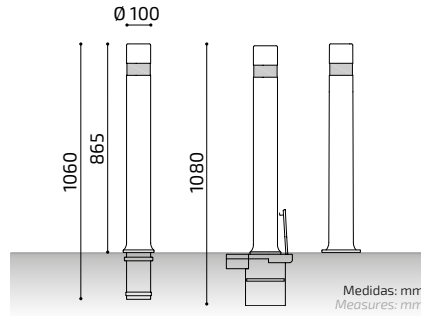

Medidas: mm.
Measures: mm.



Flexibilidad limitada.
Limited flexibility.



Opcional base con placa reforzada.
Optional base with reinforced plate.



Cinta reflectante amarilla.
Yellow reflective tape.

MODELO PATENTADO
PATENTED MODEL



A-ECO DT

PLÁSTICO POLIPROPILENO | POLYPROPYLENE PLASTIC



PECDTHN **PECDTHN**
+
BEXTRAP01 **PECDTHNP**

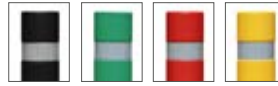

Colores estándar
Standard colors

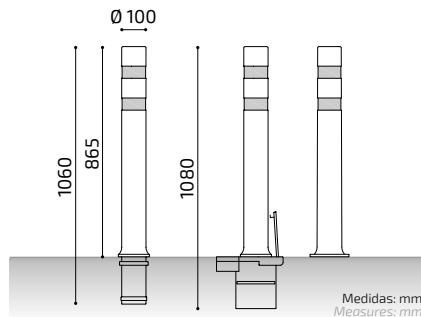

Medidas: mm.
Measures: mm.



Flexibilidad limitada.
Limited flexibility.



Opcional base con placa reforzada.
Optional base with reinforced plate.



Cinta reflectante amarilla.
Yellow reflective tape.

MODELO PATENTADO
PATENTED MODEL



A-ECO BADALONA

PLÁSTICO POLIPROPILENO | POLYPROPYLENE PLASTIC



PECBDNHN **PECBDNHN**
+
BEXTRAP01 **PECBDNHNP** **PECBDNHNT**

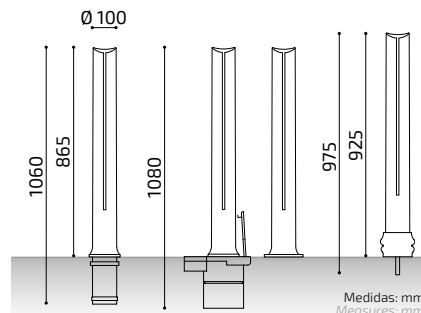

Medidas: mm.
Measures: mm.



Flexibilidad limitada.
Limited flexibility.



Opcional base con placa reforzada.
Optional base with reinforced plate.

MODELO PATENTADO
PATENTED MODEL



A-ECO SANT FELIU

PLÁSTICO POLIPROPILENO | POLYPROPYLENE PLASTIC



PECSFHN

PECSFHN

PECSFHNP

PECSFHNT

+ BEXTRAPO1

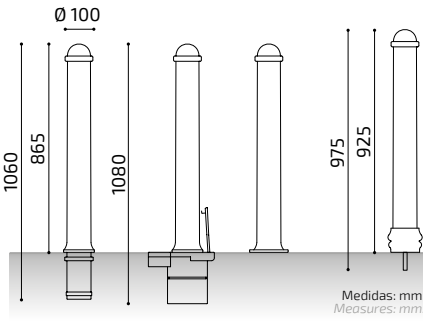

Medidas: mm.
Measures: mm.



Flexibilidad limitada.
Limited flexibility.



Opcional base con placa reforzada.
Optional base with reinforced plate.

MODELO PATENTADO
PATENTED MODEL



A-ECO AGBA

PLÁSTICO POLIPROPILENO | POLYPROPYLENE PLASTIC



PECAGBAHN

PECAGBAHN

PECAGBAHNP

PECAGBAHNT

+ BEXTRAPO1

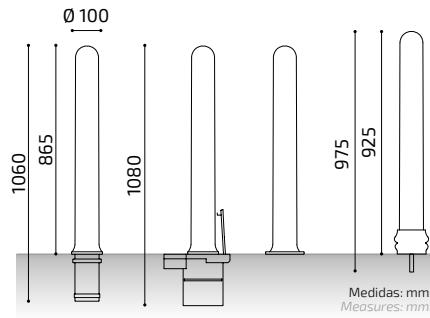

Medidas: mm.
Measures: mm.



Flexibilidad limitada.
Limited flexibility.



Opcional base con placa reforzada.
Optional base with reinforced plate.

MODELO PATENTADO
PATENTED MODEL



A-ECO FORUM

PLÁSTICO POLIPROPILENO | POLYPROPYLENE PLASTIC



PECFORUMHN

PECFORUMHN

PECFORUMHNP

PECFORUMHNT

+ BEXTRAPO1

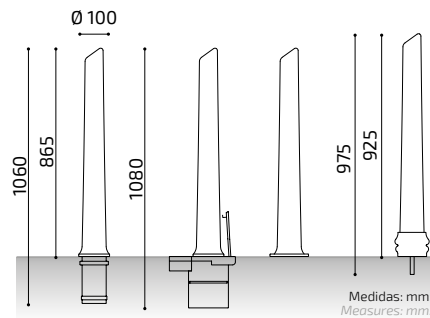

Medidas: mm.
Measures: mm.



Flexibilidad limitada.
Limited flexibility.



Opcional base con placa reforzada.
Optional base with reinforced plate.

MODELO PATENTADO
PATENTED MODEL



¡NOVEDAD!

PILONAS SEMIFLEXIBLES A-BLEN ECO CON TORNILLO

NEW!

SEMIFLEXIBLE BOLLARDS A-BLEN ECO WITH SCREW



✓ Fácil y rápida instalación.
Roscar tornillo al pavimento.
*Easy and fast installation.
Thread screw to the pavement.*

✓ Reducido coste de instalación.
Reduced installation cost.



Opcional: Llave fijación.
Optional: Key to fix the bollard.



Ø 100

A-BLEN ECO



PLÁSTICO POLIPROPILENO | POLYPROPYLENE PLASTIC



Detalle superior.
Cap detail.



Colores estándar
Standard colors



Opcional: Llave fijación.
Optional: Key to fix the bollard.

Ø 100
865

Medidas: mm.
Measures: mm.

PBLENN **LLFLEXT**

Flexibilidad limitada.
Limited flexibility.

Cinta reflectante amarilla.
Yellow reflective tape.

A-BLEN DT ECO



PLÁSTICO POLIURETANO | POLYURETHANE PLASTIC



Detalle superior.
Cap detail.



Colores estándar
Standard colors



Opcional: Llave fijación.
Optional: Key to fix the bollard.

Ø 100
865

Medidas: mm.
Measures: mm.

PBLENDTN **LLFLEXT**

Flexibilidad limitada.
Limited flexibility.

Cinta reflectante amarilla.
Yellow reflective tape.

HA75 - ECO

PLÁSTICO POLIETILENO | POLYETHYLENE PLASTIC



Opcional: Llave fijación HA75
Optional: Fixing key HA75
LLH75

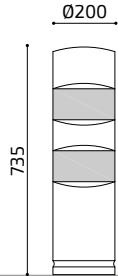

Medidas: mm.
Measures: mm.

HA75 - EVA

POLÍMERO TERMOPLÁSTICO + EVA | THERMOPLASTIC POLYMER + EVA



MAYOR RESISTENCIA A LOS IMPACTOS
HIGHER IMPACT RESISTANCE



Opcional: Llave fijación HA75
Optional: Fixing key HA75
LLH75

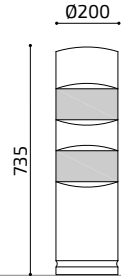

Medidas: mm.
Measures: mm.

ROAD

PLÁSTICO POLIURETANO | POLYURETHANE PLASTIC



PFLEXI3RV01

PFLEXI3RAZ01

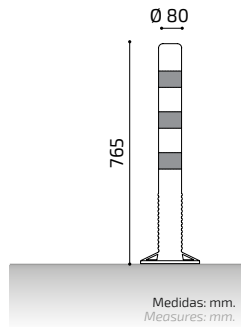

Medidas: mm.
Measures: mm.





Escanear código QR ver en web / Scan the QR code to see on web



Ver todos los modelos en la web / See all models on the web



- DIRECTIVA DE COMPATIBILIDAD ELECTROMAGNÉTICA 89/336/CEE
- DIRECTIVA DE BAJA TENSIÓN 73/23/CEE
- NORMA DE SEGURIDAD PARA SISTEMAS DE TRANSMISIONES HIDRÁULICAS EN982
- ELECTROMAGNETIC COMPATIBILITY DIRECTIVE 89/336 / EEC
- LOW VOLTAGE DIRECTIVE 73/23 / CEE
- SAFETY STANDARD FOR HYDRAULIC TRANSMISSION SYSTEMS EN982

PILONAS ESCAMOTEABLES

TELESCOPIC BOLLARDS

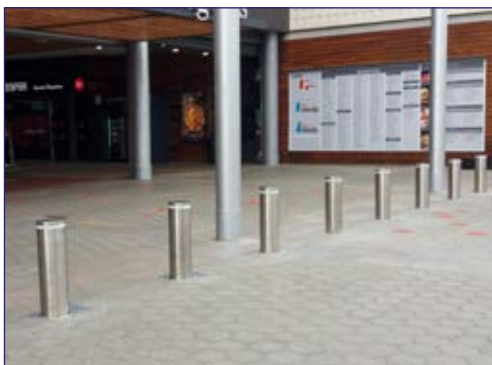

SERIE AUSTRALASIA

AUTOMÁTICA - SEMIAUTOMÁTICA. USO INTENSIVO.



AUSTRALASIA SERIE

AUTOMATIC - SEMIAUTOMATIC. INTENSIVE USE.

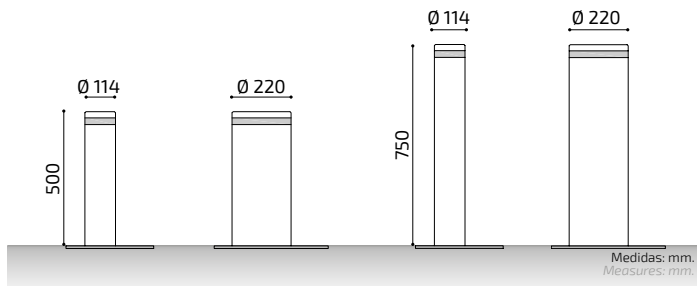

Instalación / Installation:



Bajo pedido AISI 316. / By request AISI 316.

SYDNEY

ACERO INOXIDABLE
STAINLESS STEEL



PEASY220X500

Espesor / Thickness

8,5 mm. Ø 114 mm.
8 mm. Ø 220 mm.

MELBOURNE

HIERRO GALVANIZADO
GALVANIZED IRON



PEAME220X500

Espesor / Thickness

10 mm. Ø 114 mm.
10 mm. Ø 220 mm.

SERIE ESCANDINAVIA

AUTOMÁTICA - SEMIAUTOMÁTICA. USO INTENSIVO.



ESCANDINAVIA SERIE

AUTOMATIC - SEMIAUTOMATIC. INTENSIVE USE.

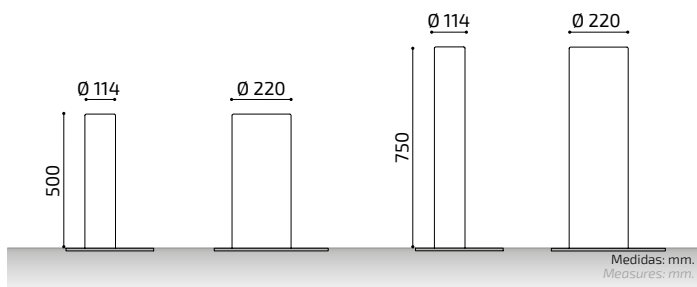

Instalación / Installation:



Bajo pedido AISI 316. / By request AISI 316.

OSLO

ACERO INOXIDABLE
STAINLESS STEEL

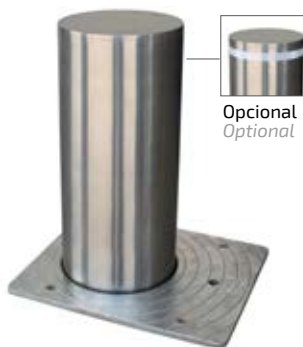

Opcional
Optional

PEMOS220X500

Espesor / Thickness

3 mm. Ø 114 mm.
3,7 mm. Ø 220 mm.

ESTOCOLMO

HIERRO GALVANIZADO
GALVANIZED IRON

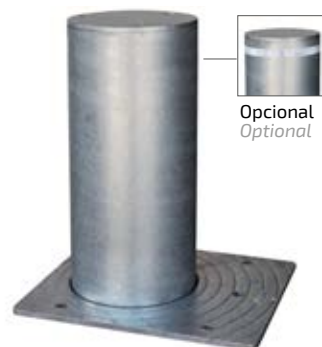

Opcional
Optional

PEMES220X500

Espesor / Thickness

4 mm. Ø 114 mm.
5 mm. Ø 220 mm.

SERIE BENELUX

AUTOMÁTICA - SEMIAUTOMÁTICA. USO COMERCIAL



BENELUX SERIE

AUTOMATIC - SEMIAUTOMATIC. COMMERCIAL USE.

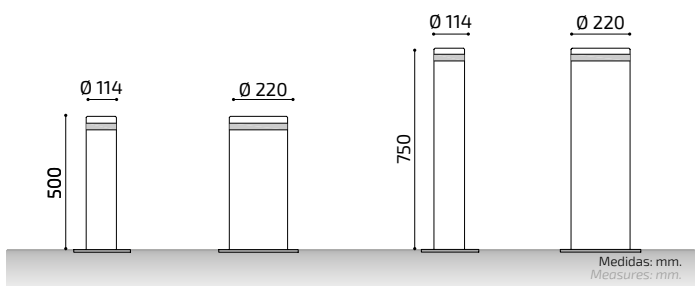

Instalación / Installation:



Bajo pedido AISI 316. / By request AISI 316.

LUXEMBURGO

ACERO INOXIDABLE
STAINLESS STEEL



PEMLU220X500

Espesor / Thickness

8,5 mm. Ø 114 mm.
8 mm. Ø 220 mm.

BRUSELAS

HIERRO GALVANIZADO
GALVANIZED IRON



PEMBR220X500

Espesor / Thickness

10 mm. Ø 114 mm.
10 mm. Ø 220 mm.

SERIE REINO UNIDO

AUTOMÁTICA - SEMIAUTOMÁTICA. USO COMERCIAL.



REINO UNIDO SERIE

AUTOMATIC - SEMIAUTOMATIC. COMMERCIAL USE.

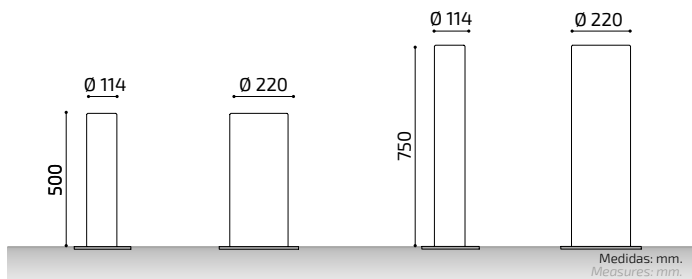

Instalación / Installation:



Bajo pedido AISI 316. / By request AISI 316.

CHELSEA

ACERO INOXIDABLE
STAINLESS STEEL



Opcional
Optional

PEMCH114X500

Espesor / Thickness
3 mm. Ø 114 mm.
3,7 mm. Ø 220 mm.

LONDON

HIERRO GALVANIZADO
GALVANIZED IRON



Opcional
Optional

PEML0220X500

Espesor / Thickness
4 mm. Ø 114 mm.
5 mm. Ø 220 mm.

SERIE UAE

AUTOMÁTICA - SEMIAUTOMÁTICA. USO INTENSIVO.



UAE SERIE

AUTOMATIC - SEMIAUTOMATIC. INTENSIVE USE.

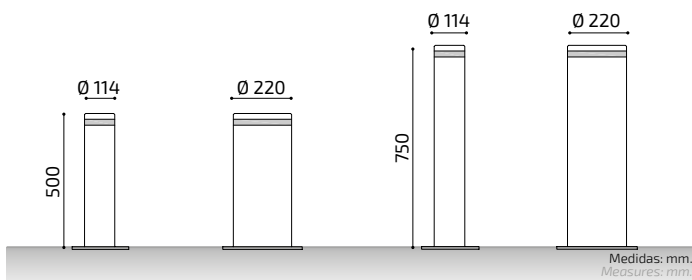

Instalación / Installation:

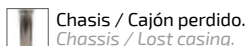

Bajo pedido AISI 316. / By request AISI 316.

ABU DABI

ACERO INOXIDABLE
STAINLESS STEEL



PEAAB220X500

Espesor / Thickness
8,5 mm. Ø 114 mm.
8 mm. Ø 220 mm.

DUBAI

HIERRO GALVANIZADO
GALVANIZED IRON



PEADU220X500

Espesor / Thickness
10 mm. Ø 114 mm.
10 mm. Ø 220 mm.

SERIE CANADÁ

AUTOMÁTICA - SEMIAUTOMÁTICA. USO INTENSIVO.



CANADA SERIE

AUTOMATIC - SEMIAUTOMATIC. INTENSIVE USE.

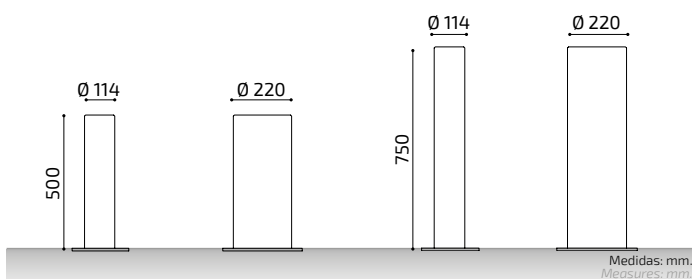

Instalación / Installation:



Bajo pedido AISI 316. / By request AISI 316.

TORONTO

ACERO INOXIDABLE
STAINLESS STEEL



Opcional
Optional

PEATO220X500

Espesor / Thickness
3 mm. Ø 114 mm.
3,7 mm. Ø 220 mm.

MONTREAL

HIERRO GALVANIZADO
GALVANIZED IRON



Opcional
Optional

PEAMO220X500

Espesor / Thickness
4 mm. Ø 114 mm.
5 mm. Ø 220 mm.

SERIE MEXICO

SEMIAUTOMÁTICA. USO MANUAL.



MEXICO SERIE

SEMIAUTOMATIC. MANUAL USE.

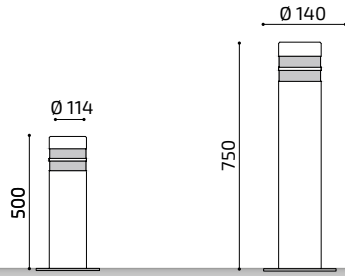

Medidas: mm.
Measures: mm.

Instalación / Installation:

Chasis / Cajón perdido.
Chassis / Lost casing.

Bajo pedido AISI 316. / By request AISI 316.

CANCUN

ACERO INOXIDABLE
STAINLESS STEEL



PEMCA140X750

Espesor / Thickness
4mm. Ø 140 mm.

TIJUANA

HIERRO GALVANIZADO
GALVANIZED IRON



PEMTI140X750

Espesor / Thickness
4 mm. Ø 140 mm.

SERIE USA

AUTOMÁTICA · SEMIAUTOMÁTICA. USO INTENSIVO.



USA SERIE

AUTOMATIC · SEMIAUTOMATIC. INTENSIVE USE.

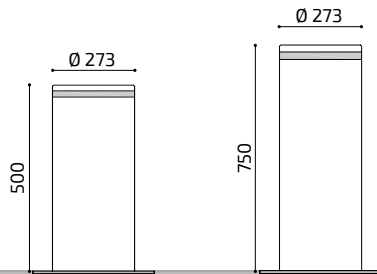

Medidas: mm.
Measures: mm.

Instalación / Installation:

Chasis. + Cajón perdido.
Chassis. + Lost casing.

Bajo pedido AISI 316. / By request AISI 316.

NEW YORK

ACERO INOXIDABLE
STAINLESS STEEL

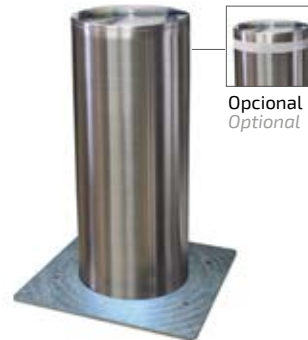

Opcional
Optional

PEMNE273X500

Espesor / Thickness
4,2 mm. Ø 273 mm.
4,2 mm. Ø 273 mm.

WASHINGTON

HIERRO GALVANIZADO
GALVANIZED IRON



PEMWA273X500

Espesor / Thickness
6,3 mm. Ø 273 mm.
6,3 mm. Ø 273 mm.



CITY TELESCOPICA MANUAL CITY TELESCOPIC MANUAL

HIERRO GALVANIZADO + ACERO INOXIDABLE | GALVANIZED IRON + STAINLESS STEEL

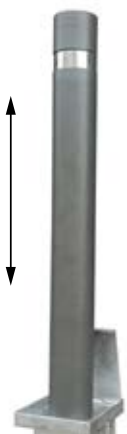

PEMCITY

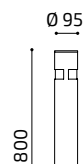

Medidas: mm.
Measures: mm.

Instalación: / Installation:

Chasis. + Cajón perdido.
Chassis. + Lost casing.

FUNCIONAMIENTO / BOLLARD OPERATION

- 1- Levantar tapa para acceder a la cerradura de la pizona.
Lift the cover to access the bollard.
- 2- Desbloquear llave y girar la pizona con ayuda de la anilla superior.
Unlock the key and rotate the bollard with help of the upper knocker.
- 3- Tirar de la anilla superior para subir la pizona y girarla para fijarla.
Pull the knocker to raise the bollard and rotate it again to fix it.
- 4- Bloquear la pizona en esa posición girando la llave y apretar el botón de la cerradura para que este no sobresalga.
Lock the bollard in that position by turning the key, be sure to press the lock button.

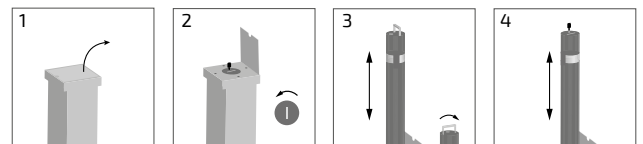

+ ACCESORIOS PILONAS ESCAMOTEABLES TELESCOPIC BOLLARDS ACCESSORIES

+ SISTEMAS DE APERTURA / APERTURE SYSTEMS



Mandos a distancia.
Remote control.



Tarjetas apertura.
Keycard.



Sistema TAG.
TAG system.



Llavín.
Latchkey.



Botonera.
Push button station.

+ SISTEMAS DE APERTURA A DISTANCIA / REMOTE OPENING SYSTEMS



Interfono GSM.
GSM intercom.



Sistema GSM.
GSM system.

+ SISTEMAS DE APERTURA LECTOR MATRÍCULAS PLATE RECOGNITION OPENING SYSTEMS



Lector de matrículas.
Car-plate recognition.



+ SISTEMAS DE APERTURA PARA VEHÍCULOS DE EMERGENCIA EMERGENCY VEHICLE OPENING SYSTEMS

Detector sonido (identifica la señal de las sirenas homologadas, ambulancias, policías, bomberos,...) y baja las pilonas para permitir el paso de los vehículos de emergencias sin detenerse.

Sound detector (identifies the signal of certified sirens, ambulances, police, firefighters, etc.) and lowers the bollards to allow the passage of emergency vehicles without stopping.





ACABADOS OPCIONALES PILONAS OPTIONAL FINISHES FOR BOLLARDS.

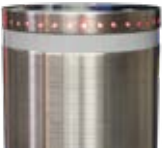

Corona luminosa CILPE.
CILPE Led ring.



Fresado extra.
Extra milling.



Personalización logo.
Customized logo.



Pilona gradiente.
Gradient bollard.



Micros posición.
Limit switches.



ACCESORIOS INSTALACIONES / ACCESSORIES FOR INSTALLATIONS

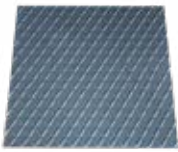

Tapa provisional obra.
Steel Road plate.



Detección apertura-tapa.
Top opening detector.



Lazo magnético.
Metallic mass detector.



Kit de conexión.
Connexion kit.



Interruptor horario anual.
Annual time switch.



Señal tráfico.
Traffic signals.



Semáforos.
Traffic lights.



Kit calefacción.
Heating.

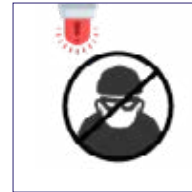

Alarma manipulado pilona.
Tampered bollard alarm.



Cajón perdido.
Lost casing.

Poste Control Accesos | Control Post URBAN

ACERO INOXIDABLE | STAINLESS STEEL



PCACCES02



Opcional protector semáforo
Optional traffic light protector

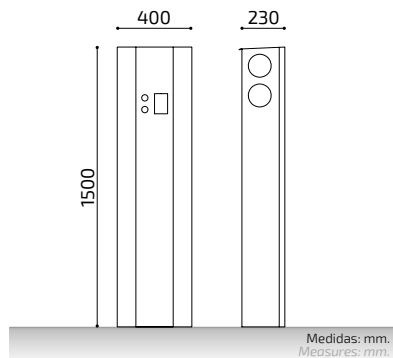

Poste Control Accesos | Control Post METROPOLIS

ACERO INOXIDABLE | STAINLESS STEEL



PCACCES04

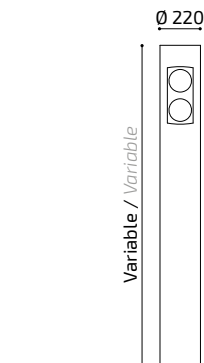

Bajo pedido AISI 316. / By request AISI 316.

Bajo pedido AISI 316. / By request AISI 316.



ADAPTACIÓN PILONAS ESCAMOTEABLES TELESCOPIC BOLLARDS ADAPTATION



Adaptación de pilonas escamoteables a cajones perdidos y/o chasis ya instalados, de otros fabricantes. Permitiendo la sustitución del vástago y otros componentes sin tener que realizar trabajos de albañilería.

Fabricación de piona y componentes a la medida que requiera el cliente, adaptando los elementos existentes.

Adaptation of telescopic bollards to already installed chassis or drawers from other manufacturers. Allowing the replacement of the stem and other components without having to perform masonry work

Manufacture of bollard and components required by the client, adapting them to existing elements.









Escanear código QR ver en web / Scan the QR code to see on web



Ver todos los modelos en la web / See all models on the web



PILONAS FIJAS PILONAS EXTRAÍBLES

*FIXED BOLLARDS
REMOVABLE BOLLARDS*



CITY

HIERRO GALVANIZADO + INOX. | GALVANIZED IRON + STAINLESS STEEL

MODELO PATENTADO
PATENTED MODEL



PCITY **PCITYE** **PCITYELS**



Cantos redondeados.
Rounded edges.



Reforzada.
Reinforced.



Logo opcional.
Optional logo.

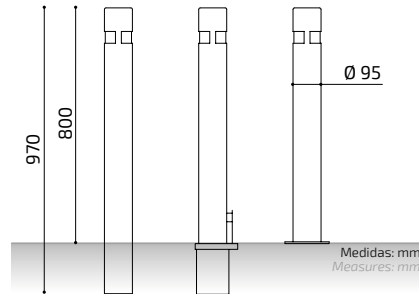

Placa opcional.
Optional plate.



Opción con candado.
Padlocked option.

BARCECO

HIERRO + INOX. | IRON + STAINLESS STEEL

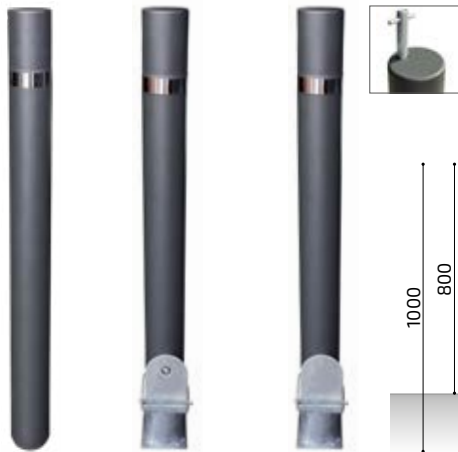

PBARCECO **PBARCECOE** **PBARCECOELS**

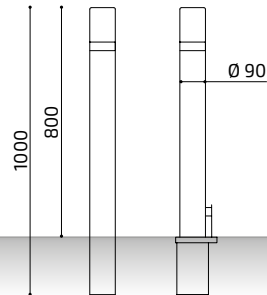

Placa opcional.
Optional plate.



Opción con candado.
Padlocked option.

URBAN

HIERRO GALVANIZADO + INOX. | GALVANIZED IRON + STAINLESS STEEL



MODELO PATENTADO
PATENTED MODEL



PURBAN **PURBANE**

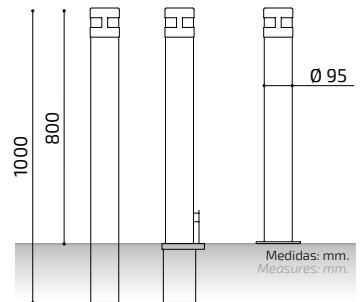

Placa opcional.
Optional plate.



Opción con candado.
Padlocked option.

CUBE

HIERRO GALVANIZADO + INOX. | GALVANIZED IRON + STAINLESS STEEL



PCUBEG **PCUBEGE**

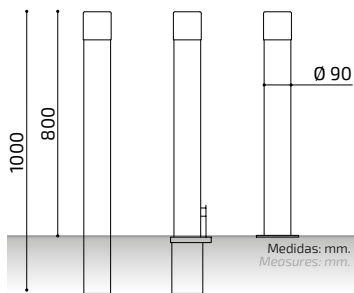

Placa opcional.
Optional plate.



Opción con candado.
Padlocked option.

TAP

HIERRO GALVANIZADO + INOX. | GALVANIZED IRON + STAINLESS STEEL



PTAPG01 **PTAPG01E**

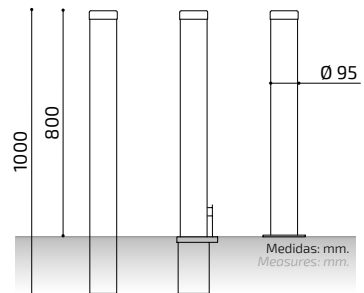

Placa opcional.
Optional plate.



Opción con candado.
Padlocked option.

TUBULAR

HIERRO GALVANIZADO • HIERRO | GALVANIZED IRON • IRON



PTUBULARG **PTUBULARGE**

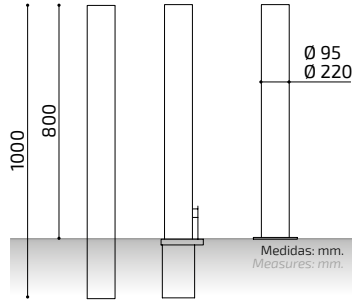

Placa opcional.
Optional plate.



Opción con candado.
Padlocked option.

CILINDRO

HIERRO GALVANIZADO • HIERRO | GALVANIZED IRON • IRON



PHGC **PHGCE**

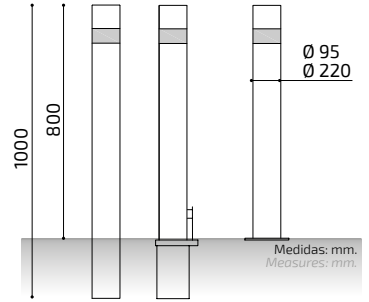

Placa opcional.
Optional plate.



Opción con candado.
Padlocked option.

GRANOLLERS

HIERRO | IRON



PGOLLERB01 **PGOLLERAN01**

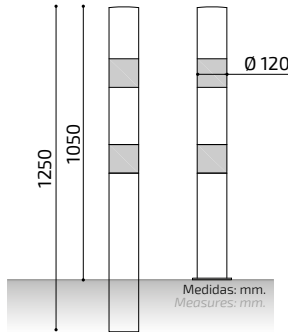

Placa opcional.
Optional plate.



Opción con candado.
Padlocked option.

CORTE

HIERRO GALVANIZADO • HIERRO | GALVANIZED IRON • IRON



PCORTEG **PCORTEGE**

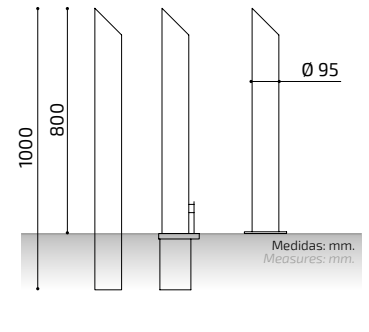

Placa opcional.
Optional plate.



Opción con candado.
Padlocked option.

GREY

HIERRO | IRON



PGREYG **PGREYGE**

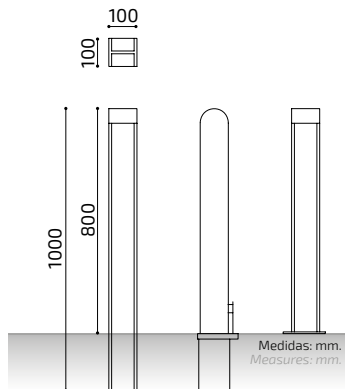

Placa opcional.
Optional plate.



Opción con candado.
Padlocked option.

IPN

HIERRO | IRON

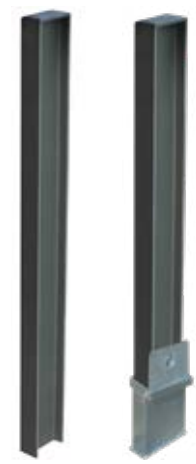

PIPNG **PIPNGE**

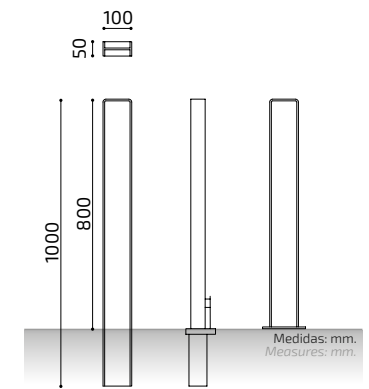

Placa opcional.
Optional plate.



Opción con candado.
Padlocked option.

FLAG

HIERRO | IRON



Bajo pedido, personalización de colores / banderas.

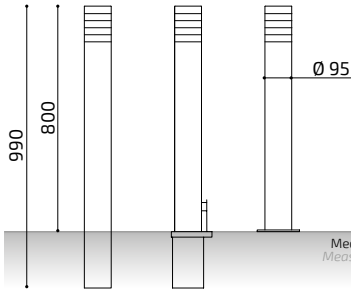

Medidas: mm.
Measures: mm.

PFLAG01 **PFLAG01E**



Placa opcional.
Optional plate.



Opción con candado.
Padlocked option.

BADALONA

HIERRO | IRON

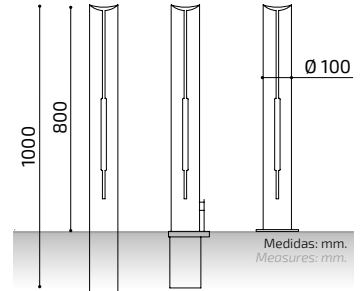

Medidas: mm.
Measures: mm.

PHBDN **PHBDNE**



Placa opcional.
Optional plate.



Opción con candado.
Padlocked option.

ESQUIROL

HIERRO | IRON



Opcional
Optional

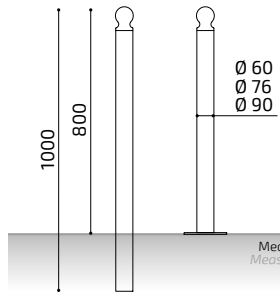

Medidas: mm.
Measures: mm.

PESQUIROL01



Placa opcional.
Optional plate.

PROTECTOR

HIERRO GALVANIZADO • CORTEN | GALVANIZED IRON • CORTEN

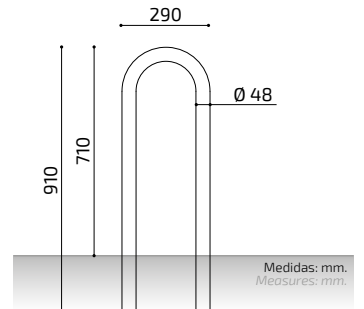

Medidas: mm.
Measures: mm.

PPROTECTORAM

PROTEC

HIERRO | IRON



Detalle
Detail

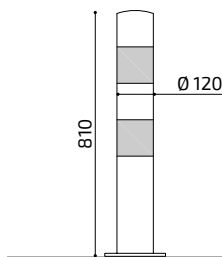

Medidas: mm.
Measures: mm.

PPROTECRB **PPROTECAMN**

HELMET

HIERRO | IRON



Detalle
Detail

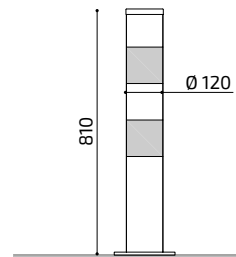

Medidas: mm.
Measures: mm.

PHELMETRB **PHELMETAMN**

WEMBLEY

HIERRO GALVANIZADO | GALVANIZED IRON



Opcional
Optional

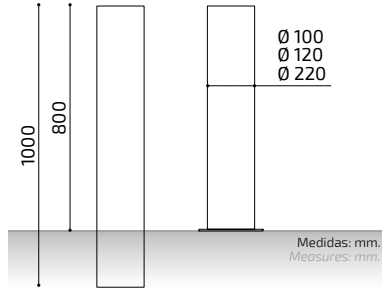

PWEMBLEY

Placa opcional.
Optional plate.

MK

HIERRO | IRON



Opcional
Optional

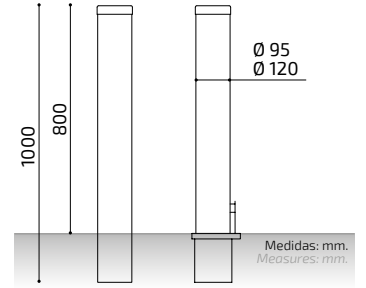

PMKAM

PMKAME

OLD

CORTEN | CORTEN STEEL

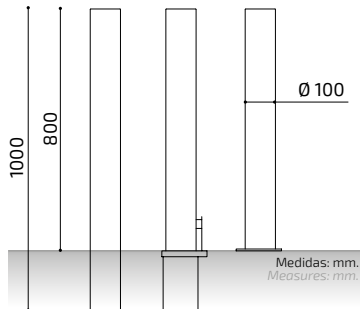

POLDC100

POLDC100E

Placa opcional.
Optional plate. | Opción con candado.
Padlocked option.

DESMON

HIERRO | IRON

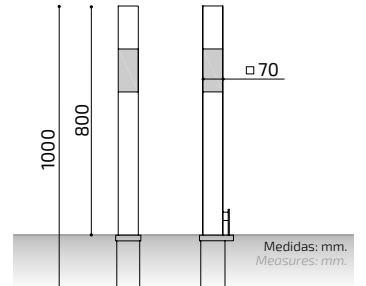

PDESMON

+ PILONAS DE HORMIGÓN / CONCRETE BOLLARDS



Hormigón



Semiesfera hormigón



Cube



Deca



Cilin



Leo



ROPE

MADERA | WOOD



PROPE100

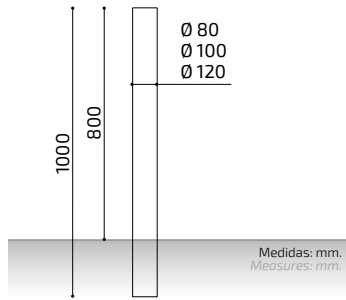

PINO

MADERA | WOOD



PPINO

PPINOE



Opción Eco (136 mm)
Eco option (136 mm)

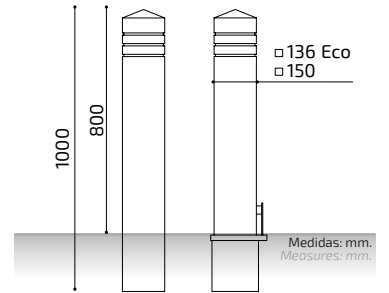

INOX

ACERO INOX. | STAINLESS STEEL



PINOX104B

PINOX104BE

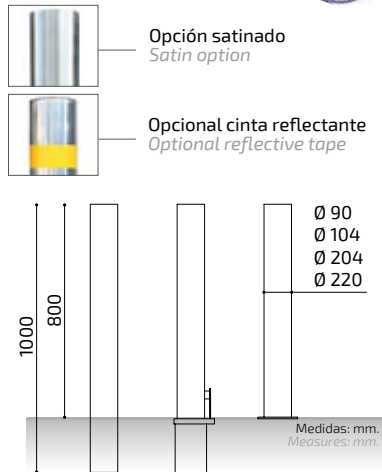

Placa opcional.
Optional plate.

Opción con candado.
Padlocked option.

DECOR

ACERO INOX. | STAINLESS STEEL



PIDECOR104B

PIDECOR104BE

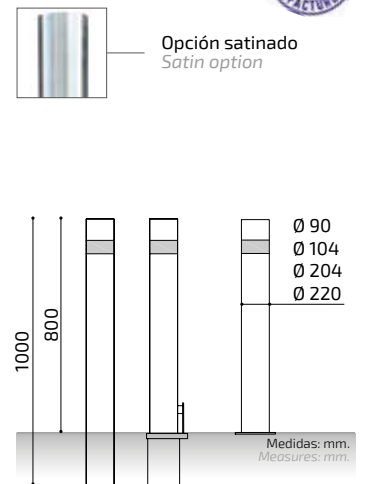

Placa opcional.
Optional plate.

Opción con candado.
Padlocked option.

TECOR

ACERO INOX. | STAINLESS STEEL



PITECOR104B

PITECOR104BE

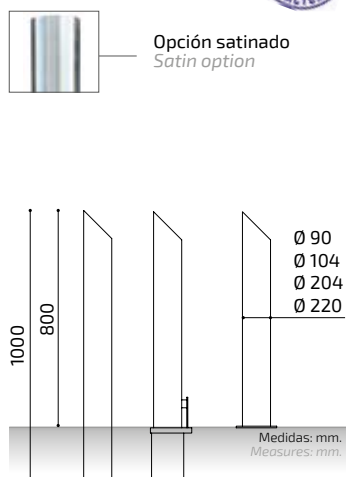

Placa opcional.
Optional plate.

Opción con candado.
Padlocked option.

TECORA

ACERO INOX. | STAINLESS STEEL



PITECORA104B

PITECORA104BE

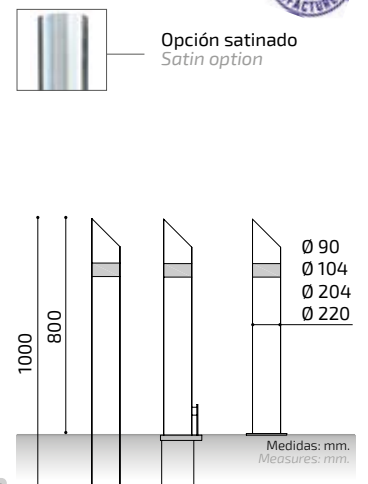

Placa opcional.
Optional plate.

Opción con candado.
Padlocked option.

BCN

HIERRO | IRON



Tapa registrable
Refillable cap

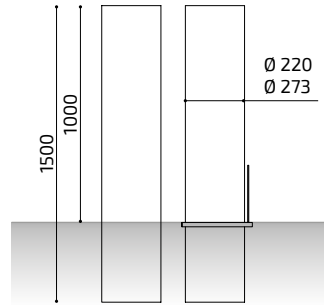

PSEGRBCNG01 PSEGRBCNG01E

Rellenable hormigón.
Refillable concrete.

BARCELONA

HIERRO + ACERO INOX. | IRON + STAINLESS STEEL



Tapa registrable
Refillable cap

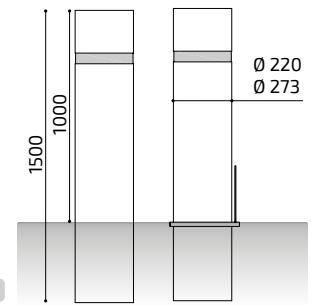

PSEGRBARNAG01 PSEGRBARNAG01E

Rellenable hormigón.
Refillable concrete.

BIG GREY

HIERRO | IRON

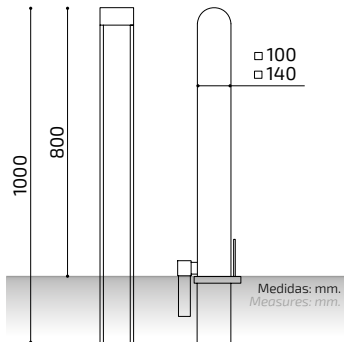

Medidas: mm.
Measures: mm.

PSEGGREY140G PSGREYGE

Base galvanizada.
Galvanized Base.

MK EXTRAÍBLE

HIERRO | IRON

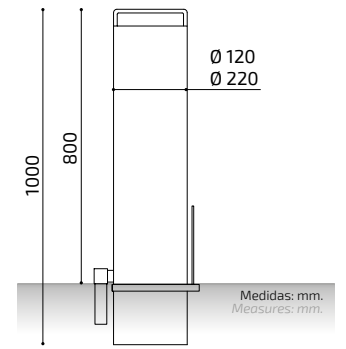

Medidas: mm.
Measures: mm.

PMK120X750AM

Base galvanizada.
Galvanized Base.

CIRCULAR

HIERRO • ACERO INOX. | IRON • STAINLESS STEEL



Opción satinado
Satin option

Núcleo interno de hierro reforzado
Internal core of reinforced iron

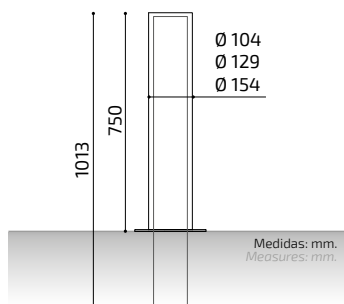

Medidas: mm.
Measures: mm.

PSEGR150G PSEGR104

Rellenable hormigón.
Refillable concrete.

CIRCULAR ECO

HIERRO • ACERO INOX. | IRON • STAINLESS STEEL



Opción satinado
Satin option

Núcleo interno de hierro reforzado
Internal core of reinforced iron

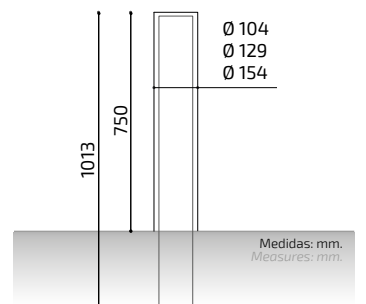

Medidas: mm.
Measures: mm.

PSEGRECO150G PSEGR154

Rellenable hormigón.
Refillable concrete.

CUADRADA INOX

ACERO INOX. | STAINLESS STEEL



Opción satinado
Satin option

Núcleo interno de hierro reforzado
Internal core of reinforced iron

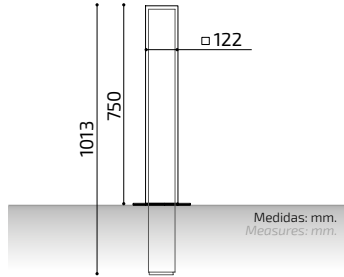

Medidas: mm.
Measures: mm.

PSEGC122

Rellenable hormigón.
Refillable concrete.

INOX EXTRAÍBLE

ACERO INOX. | STAINLESS STEEL



Opción satinado
Satin option

Núcleo interno de hierro reforzado
Internal core of reinforced iron

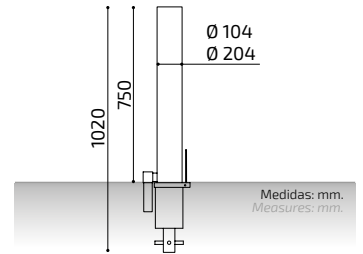

Medidas: mm.
Measures: mm.

PSGR104E

Rellenable hormigón.
Refillable concrete.

CITY LED

HIERRO GALVANIZADO + INOX. | GALVANIZED IRON + STAINLESS STEEL



MODELO PATENTADO
PATENTED MODEL

1,2,3 o 4 leds
1,2,3 or 4 leds

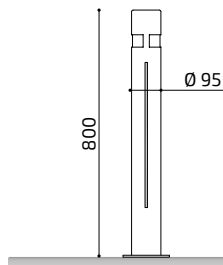

Medidas: mm.
Measures: mm.

PCITYNLVB

PCITYNLVR

Bajo consumo 12v.
Low-energy 12v.

CITY LED HEAD

HIERRO | IRON



MODELO PATENTADO
PATENTED MODEL

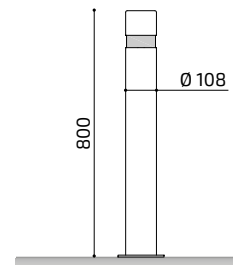

Medidas: mm.
Measures: mm.

PCITYL

Bajo consumo 12v.
Low-energy 12v.

URBAN LED

HIERRO GALVANIZADO + INOX. | GALVANIZED IRON + STAINLESS STEEL



MODELO PATENTADO
PATENTED MODEL

1,2,3 o 4 leds
1,2,3 or 4 leds

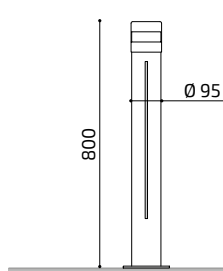

Medidas: mm.
Measures: mm.

PURBANNLVB

PURBANNLVR

Bajo consumo 12v.
Low-energy 12v.

URBAN LED HEAD

HIERRO GALVANIZADO + INOX. | GALVANIZED IRON + STAINLESS STEEL



MODELO PATENTADO
PATENTED MODEL

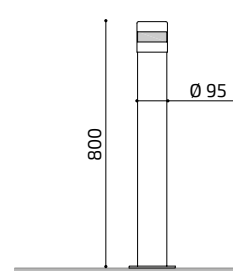

Medidas: mm.
Measures: mm.

PURBANNLHB

Bajo consumo 12v.
Low-energy 12v.

TAP LED

HIERRO GALVANIZADO + INOX. | GALVANIZED IRON + STAINLESS STEEL

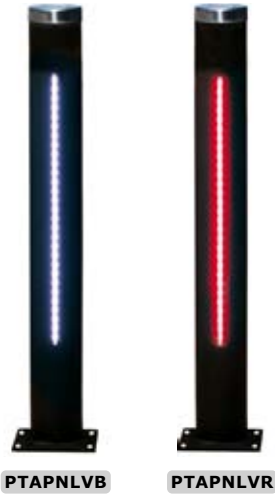

MODELO PATENTADO
PATENTED MODEL

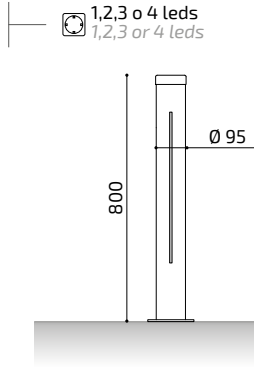

Medidas: mm.
Measures: mm.

Bajo consumo 12v.
Low-energy 12v.

TAP LED TOP

HIERRO GALVANIZADO + HIERRO | GALVANIZED IRON + IRON



MODELO PATENTADO
PATENTED MODEL

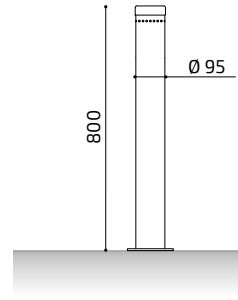

Medidas: mm.
Measures: mm.

Bajo consumo 12v.
Low-energy 12v.

KRONO

ACERO INOX. | STAINLESS STEEL

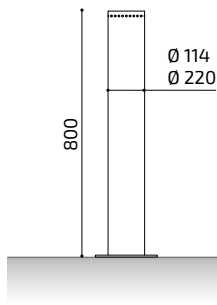

Medidas: mm.
Measures: mm.

Bajo consumo 12v.
Low-energy 12v.

ROGI

ACERO INOX. | STAINLESS STEEL

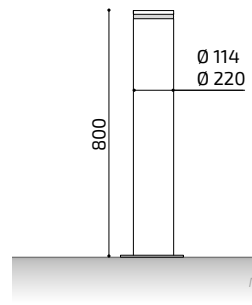

Medidas: mm.
Measures: mm.

Bajo consumo 12v.
Low-energy 12v.

INOX LED

ACERO INOX. | STAINLESS STEEL

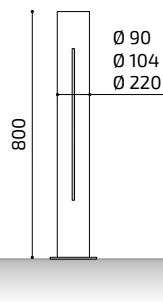
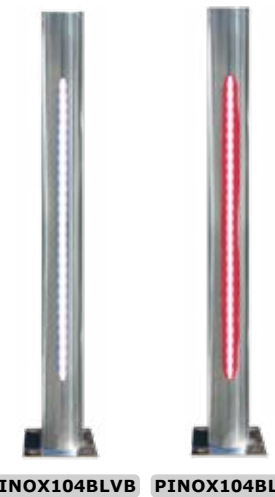

Medidas: mm.
Measures: mm.

Bajo consumo 12v.
Low-energy 12v.

OLD LED

ACERO CORTEN | STEEL CORTEN

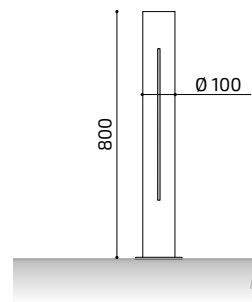

Medidas: mm.
Measures: mm.

Bajo consumo 12v.
Low-energy 12v.

INFO LED

HIERRO • CORTEN + INOX. | IRON • CORTEN + STAINLESS STEEL



Diseño personalizado
Personalized design

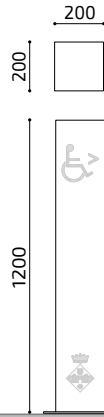

Medidas: mm.
Measures: mm.



PINFOC01

Bajo consumo 12v.
Low-energy 12v.





PILONAS LUMINOSAS CON LED FLEXIBLES Y SEMIFLEXIBLES

FLEXIBLE AND SEMI FLEXIBLE LED LIGHT BOLLARDS



Pilona flexible luminosa con led en la parte superior pudiendo elegir color de led blanco ó led rojo, Otros colores y configuraciones a consultar (leds RGB), programación horaria, ...

Flexible light bollard with led on the top led color can be chosen between white and red. Other colors, settings (leds RGB) and time scheduling to be consulted.

A-FLEX LEDS

PLÁSTICO POLIURETANO | POLYURETHANE PLASTIC

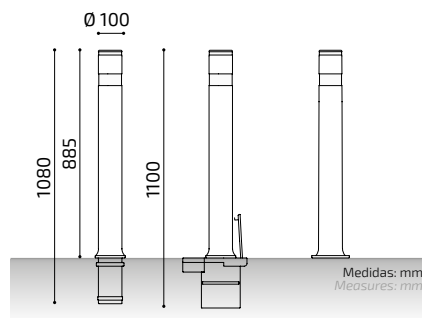

Flexibilidad 90°.
Flexibility 90°.



Posibilidad doble tira.
Double strip possibility.



Bajo consumo 12v.
Low-energy 12v.

A-ECO LEDS

PLÁSTICO POLIPROPILENO | POLYPROPYLENE PLASTIC

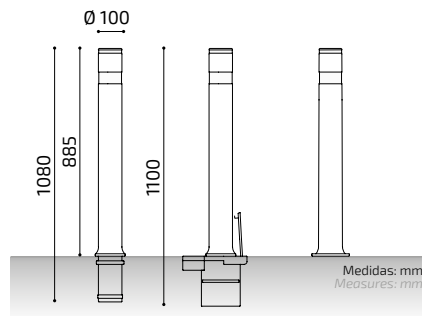

Flexibilidad limitada.
Limited flexibility.



Posibilidad doble tira.
Double strip possibility.



Bajo consumo 12v.
Low-energy 12v.



Escanear código QR ver en web / Scan the QR code to see on web



Ver todos los modelos en la web / See all models on the web



PILONAS ABATIBLES BARRERAS MANUALES

FOLD DOWN BOLLARDS MANUAL BARRIERS

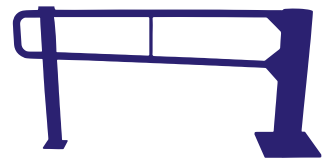

Barrera Abatible | *Fold Down Barrier*
BAM

HIERRO GALVANIZADO | GALVANIZED IRON

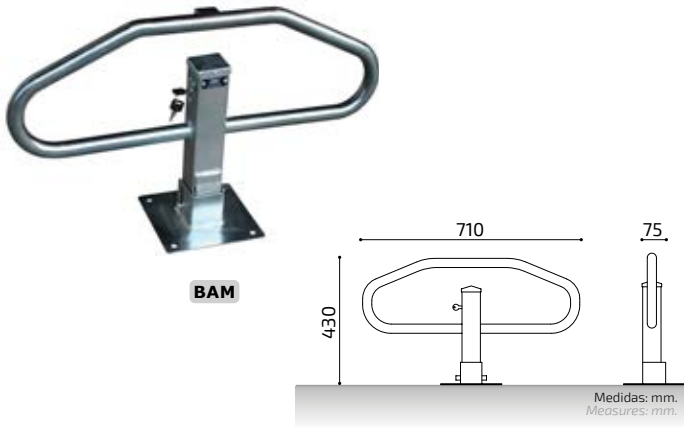

-  Candado. Padlock.
-  Opcional llave igualada. Optional matched key.

Barrera Abatible | *Fold Down Barrier*
RODAS

HIERRO GALVANIZADO | GALVANIZED IRON

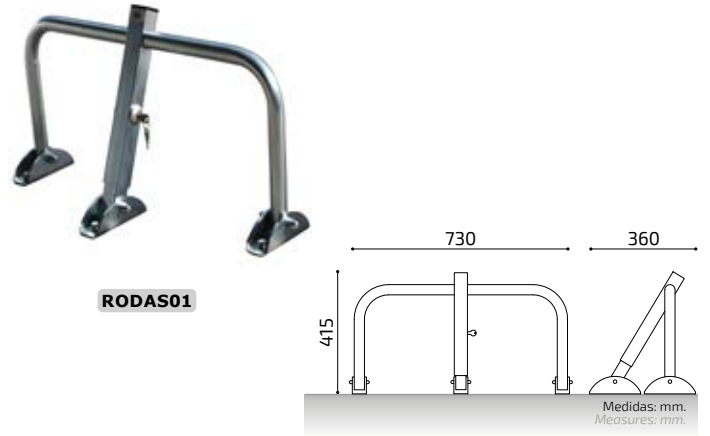

-  Candado. Padlock.
-  Opcional llave igualada. Optional matched key.

Barrera Abatible | *Fold Down Barrier*
VOLOS

HIERRO GALVANIZADO | GALVANIZED IRON

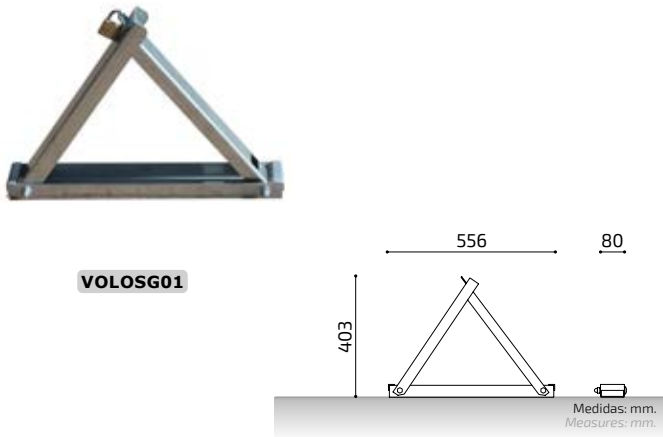



-  Candado. Padlock.

Pilona Abatible | *Fold Down Barrier*
TROYA

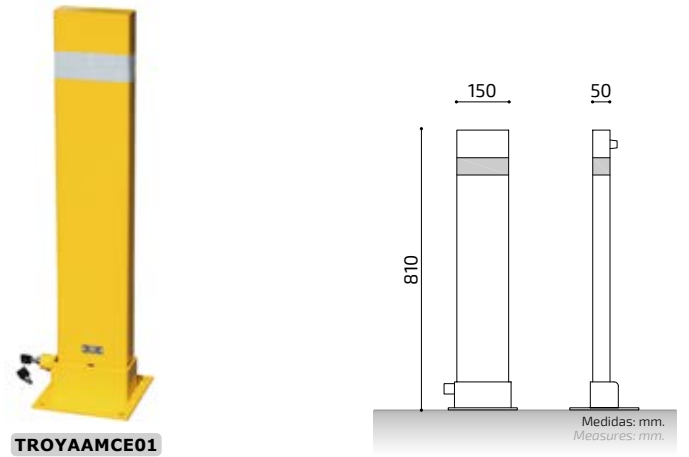
HIERRO | IRON





-  Candado. Padlock.
-  Cerradura. Lock.
-  Opcional llave igualada. Optional matched key.

Pilona Abatible | *Fold Down Barrier*
POMPEYA

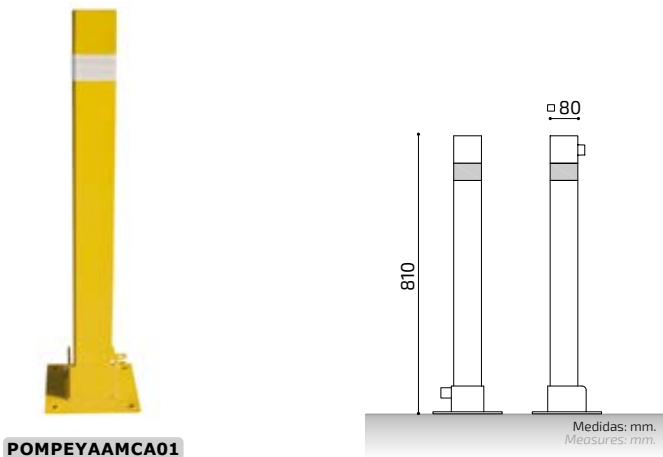
HIERRO | IRON



-  Candado. Padlock.
-  Cerradura. Lock.
-  Opcional llave igualada. Optional matched key.

Pilona Abatible | *Fold Down Barrier*
ATENAS

HIERRO | IRON

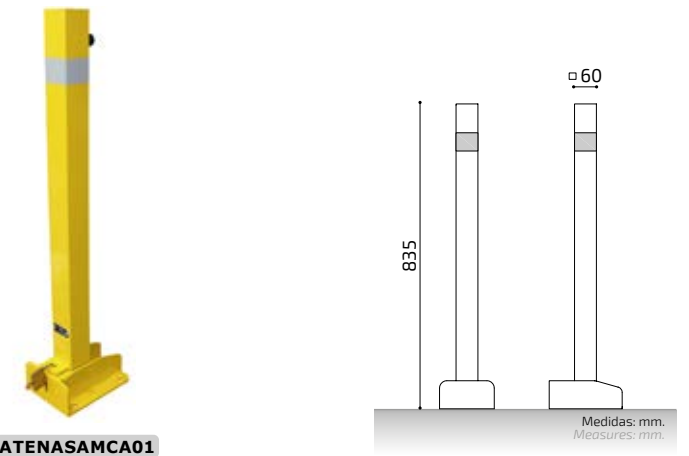

-  Candado. Padlock.

Pilona Abatible | *Fold Down Barrier*
FOLD

HIERRO | IRON



FOLDGCE01

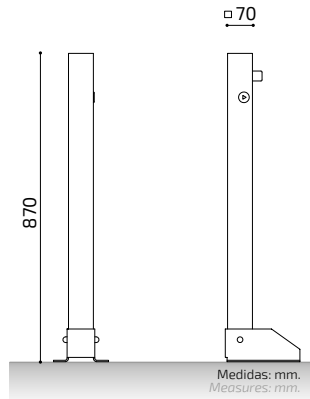

Medidas: mm.
Measures: mm.

Candado.
Padlock.

Pilona Abatible | *Fold Down Bollard*
STC / STC A-FLEX

PILONA | PILONA FLEXIBLE
 BOLLARD | FLEXIBLE BOLLARDS

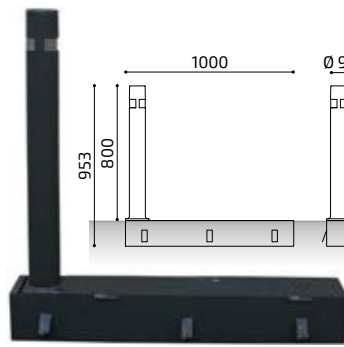

PILONASTC

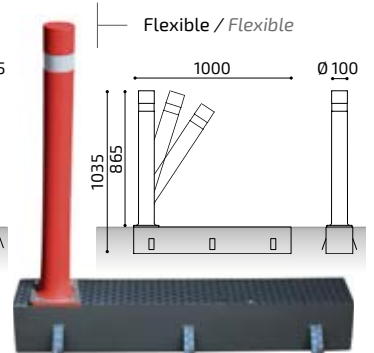

PILONASTC-A

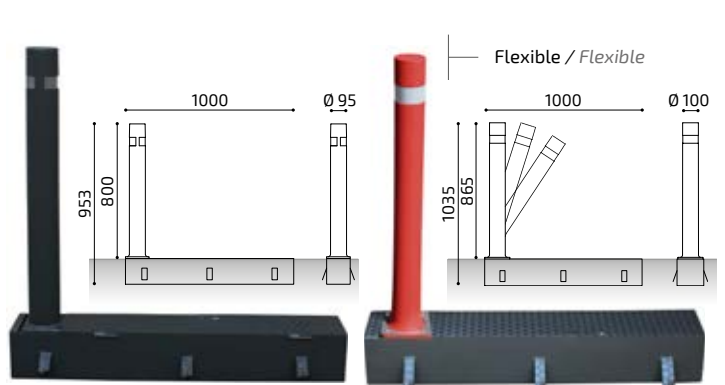

Barrera | *Barrier*
GIRATORIA

HIERRO | IRON

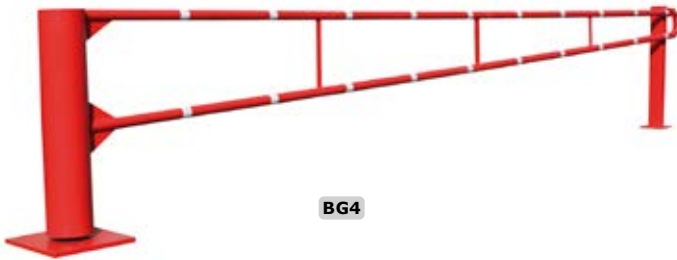

BG4



BGE4

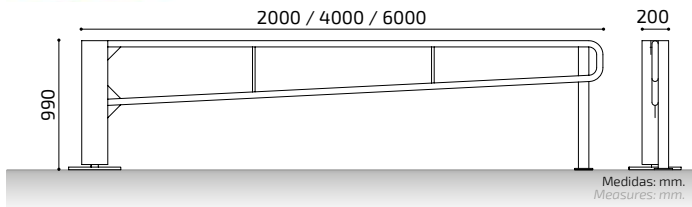

Medidas: mm.
Measures: mm.

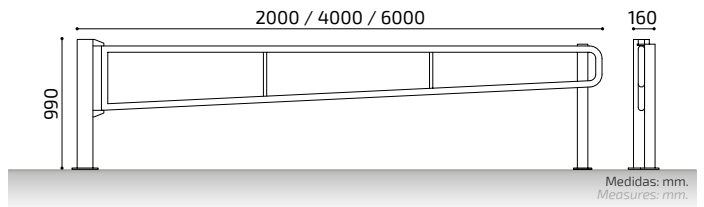

Medidas: mm.
Measures: mm.

Barrera | *Barrier*
GIRATORIA BMGC

HIERRO | IRON

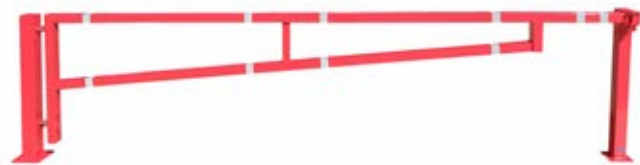

BMGC4

ABG

Barrera | *Barrier*
ELEVABLE BM6

HIERRO | IRON



BM6

ABM6

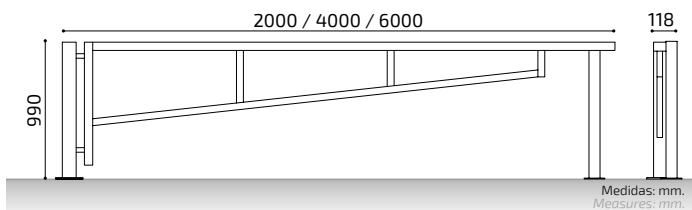

Medidas: mm.
Measures: mm.

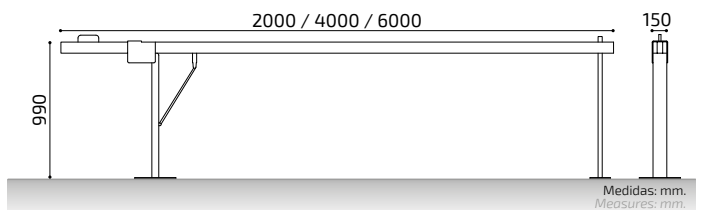

Medidas: mm.
Measures: mm.





Escanear código QR ver en web / Scan the QR code to see on web



Ver todos los modelos en la web / See all models on the web



BANCOS URBANOS

URBAN BENCHES





BANCOS DE PLÁSTICO Y MADERA / PLASTIC AND WOOD BENCHES

Bancos construidos con patas de gran resistencia en plástico reciclable. Tratamiento ultravioleta. Listones de madera tropical.

Benches built with highly resistant legs made of recyclable plastic. UV treatment. Tropical Wood slats.



DAWN



MADERA • PLÁSTICO | WOOD • PLASTIC

Banco / Bench Silla / Chair



Patas plástico reciclable
Recyclable plastic legs
Plástico de gran calidad
High quality plastic

BDAWNP01

SDAWNPO1

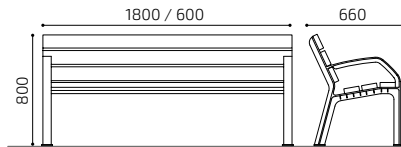

Medidas: mm.
Measures: mm.

NIGHTFALL



MADERA • PLÁSTICO | WOOD • PLASTIC

Banco / Bench Silla / Chair



Patas plástico reciclable
Recyclable plastic legs
Plástico de gran calidad
High quality plastic

BNIGHTFALLP01

SNIGHTFALLP01

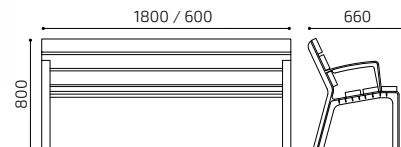

Medidas: mm.
Measures: mm.



LOA

MADERA • HIERRO • CORTEN • INOX. | WOOD • IRON • CORTEN • STAINLESS STEEL



Banco / Bench Silla / Chair



BLOAG01

SLOAG01

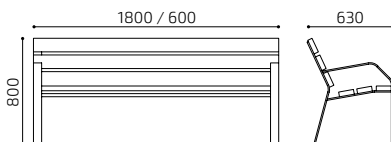

Medidas: mm.
Measures: mm.

ESTROFA

MADERA • HIERRO • CORTEN • INOX. | WOOD • IRON • CORTEN • STAINLESS STEEL



Banco / Bench Silla / Chair



BESTROFAG01

SESTROFAG01

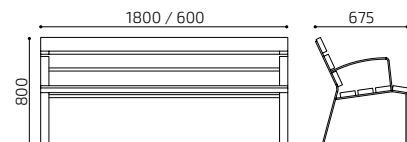

Medidas: mm.
Measures: mm.

ESTILO

MADERA • HIERRO • CORTEN • INOX. | WOOD • IRON • CORTEN • STAINLESS STEEL



Banco / Bench Silla / Chair



BESTILOG01



SESTILOG01

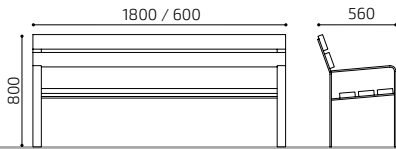

Medidas: mm.
Measures: mm.

ACORDE

MADERA • HIERRO • CORTEN • INOX. | WOOD • IRON • CORTEN • STAINLESS STEEL



Banco / Bench Silla / Chair



BACORDEG01



SACORDEG01

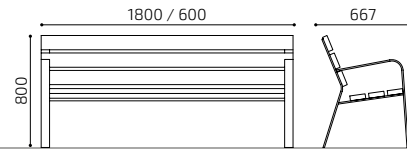

Medidas: mm.
Measures: mm.

DAMA

MADERA • HIERRO • CORTEN • INOX. | WOOD • IRON • CORTEN • STAINLESS STEEL



Banco / Bench Silla / Chair



BDAMAG01



SDAMAG01

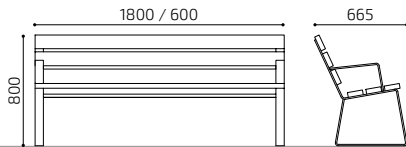

Medidas: mm.
Measures: mm.

NOTE

MADERA • HIERRO • CORTEN • INOX. | WOOD • IRON • CORTEN • STAINLESS STEEL



Banco / Bench Silla / Chair



BNOTEG01



SNOTEG01

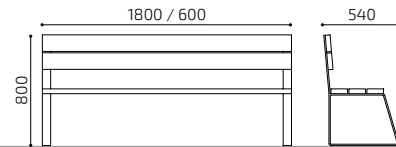

Medidas: mm.
Measures: mm.

UNAMUNO

MADERA • HIERRO • CORTEN • INOX. | WOOD • IRON • CORTEN • STAINLESS STEEL



Banco / Bench Silla / Chair



BUNAMUNOG01



SUNAMUNOG01

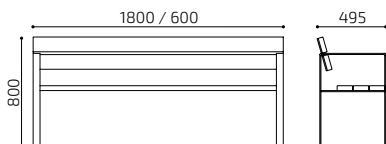

Medidas: mm.
Measures: mm.

HIMNO

MADERA • HIERRO • CORTEN • INOX. | WOOD • IRON • CORTEN • STAINLESS STEEL



Banco / Bench Silla / Chair



BHIMNOG01



SHIMNOG01

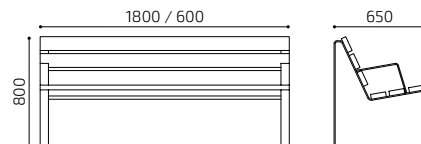

Medidas: mm.
Measures: mm.

LORCA

MADERA • HIERRO • CORTEN • INOX. | WOOD • IRON • CORTEN • STAINLESS STEEL



Banco / Bench Silla / Chair



BLORCAG01



SLORCAG01

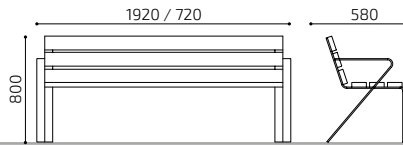

Medidas: mm.
Measures: mm.

CERVANTES

MADERA • HIERRO • CORTEN • INOX. | WOOD • IRON • CORTEN • STAINLESS STEEL



Banco / Bench Silla / Chair



BCERVANTESG01



SCERVANTESG01

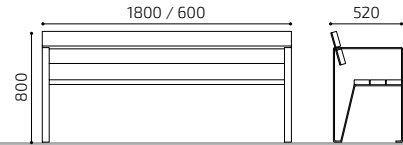

Medidas: mm.
Measures: mm.

VERSO

ADO design

MADERA • HIERRO • CORTEN • INOX. | WOOD • IRON • CORTEN • STAINLESS STEEL



Banco / Bench Silla / Chair Banqueta / Low bench



BVERSOIC

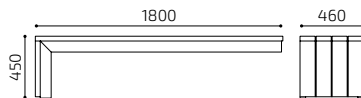

Medidas: mm.
Measures: mm.

PROSA

MADERA • HIERRO • CORTEN • INOX. | WOOD • IRON • CORTEN • STAINLESS STEEL



Banco / Bench Silla / Chair Banqueta / Low bench



BPROSAG01



SPROSAG01

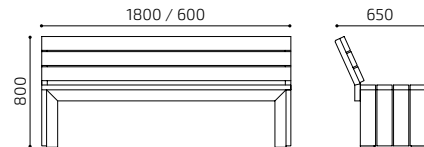

Medidas: mm.
Measures: mm.

TEATRO

MADERA • HIERRO • CORTEN • INOX. | WOOD • IRON • CORTEN • STAINLESS STEEL



Banco / Bench Silla / Chair Banqueta / Low bench



BTEATROC01



STEATROC01



Medidas: mm.
Measures: mm.

DICKENS

MADERA • HIERRO • CORTEN • INOX. | WOOD • IRON • CORTEN • STAINLESS STEEL



Banco / Bench Silla / Chair Banqueta / Low bench



BDICKENSG01

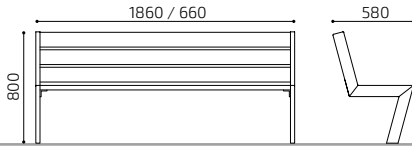

Medidas: mm.
Measures: mm.

ORIGAMI

ADO design

MADERA • HIERRO • CORTEN • INOX. | WOOD • IRON • CORTEN • STAINLESS STEEL



Banco / Bench Silla / Chair Banqueta / Low bench



BORIGAMIG01

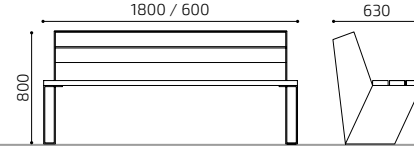
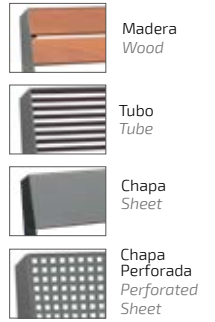

Medidas: mm.
Measures: mm.

NOVELA

ADO design

MADERA • HIERRO • CORTEN • INOX. | WOOD • IRON • CORTEN • STAINLESS STEEL



Banco / Bench Silla / Chair Banqueta / Low bench



BNOVELAI01

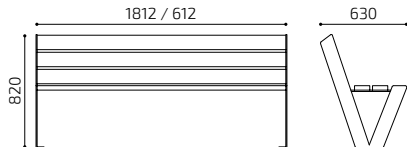

Medidas: mm.
Measures: mm.

POESIA

MADERA • HIERRO • CORTEN • INOX. | WOOD • IRON • CORTEN • STAINLESS STEEL



Banco / Bench Silla / Chair Banqueta / Low bench



BPOESIAG01

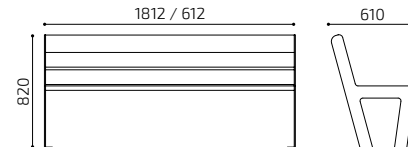

Medidas: mm.
Measures: mm.

LEYEND

ADO design

MADERA • HIERRO • CORTEN • INOX. | WOOD • IRON • CORTEN • STAINLESS STEEL



Banco / Bench Silla / Chair Banqueta / Low bench



BLEYENDG01

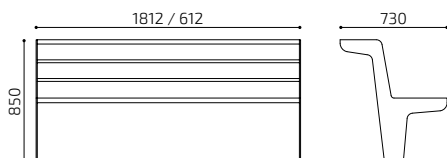
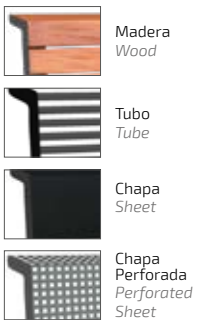

Medidas: mm.
Measures: mm.

GALA

ADO design

MADERA • HIERRO • CORTEN • INOX. | WOOD • IRON • CORTEN • STAINLESS STEEL



Banco / Bench Silla / Chair Banqueta / Low bench



BGALAG01

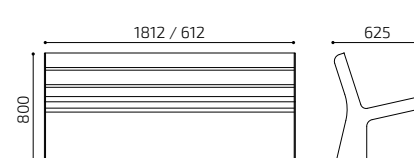

Medidas: mm.
Measures: mm.

ENTE

MADERA • HIERRO • CORTEN • INOX. | WOOD • IRON • CORTEN • STAINLESS STEEL



Banco / Bench Silla / Chair Banqueta / Low bench



BENTEG01

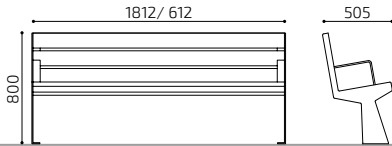

Medidas: mm.
Measures: mm.

ENERRE

MADERA • HIERRO • CORTEN • INOX. | WOOD • IRON • CORTEN • STAINLESS STEEL



Banco / Bench Silla / Chair Banqueta / Low bench



BENERREG01

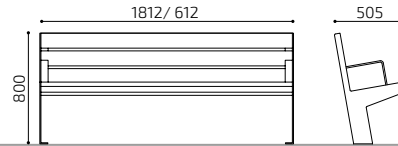

Medidas: mm.
Measures: mm.

SADE

HIERRO • CORTEN • INOX. | IRON • CORTEN • STAINLESS STEEL



Banco / Bench Silla / Chair Banqueta / Low bench



BSADEG01

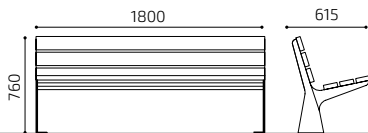
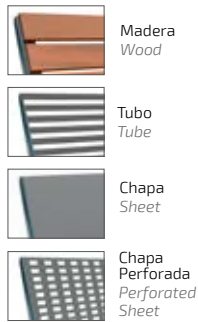

Medidas: mm.
Measures: mm.

VERNE

ADO design

MADERA • HIERRO • CORTEN • INOX. | WOOD • IRON • CORTEN • STAINLESS STEEL



Banco / Bench



BVERNEG01

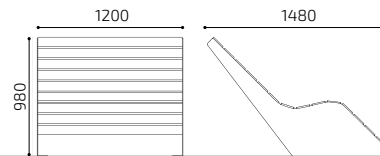

Medidas: mm.
Measures: mm.

MISTRAL

MADERA • HIERRO • CORTEN • INOX. | WOOD • IRON • CORTEN • STAINLESS STEEL



Banqueta / Low bench



BMISTRALG01

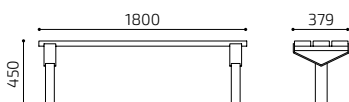
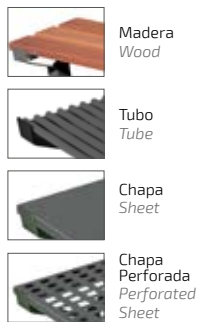

Medidas: mm.
Measures: mm.

ALLENDE

MADERA • HIERRO • CORTEN • INOX. | WOOD • IRON • CORTEN • STAINLESS STEEL



Banqueta / Low bench



BALLENDEG01

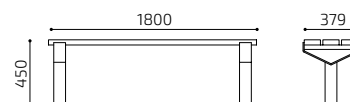

Medidas: mm.
Measures: mm.

EPICA

MADERA • HIERRO • CORTEN • INOX. | WOOD • IRON • CORTEN • STAINLESS STEEL



Banqueta / Low bench



BEPICA02

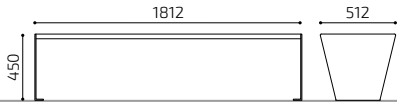
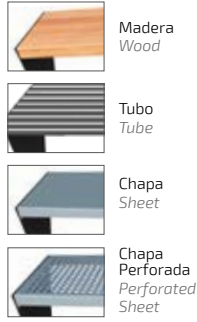

Medidas: mm.
Measures: mm.

SQUARED

MADERA • HIERRO • CORTEN • INOX. | WOOD • IRON • CORTEN • STAINLESS STEEL



Banqueta / Low bench



BSQUAREDG01

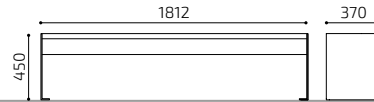

Medidas: mm.
Measures: mm.

TALI

MADERA • HIERRO • CORTEN • INOX. | WOOD • IRON • CORTEN • STAINLESS STEEL



Banqueta / Low bench



BTALIG02

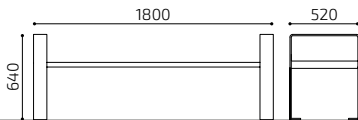

Medidas: mm.
Measures: mm.

VARGAS

MADERA • HIERRO • CORTEN • INOX. | WOOD • IRON • CORTEN • STAINLESS STEEL



Banqueta / Low bench



BVARGASG01

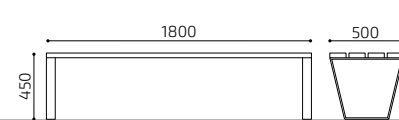
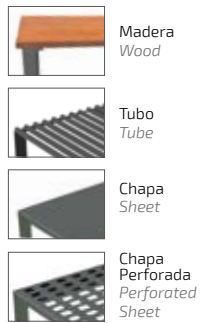

Medidas: mm.
Measures: mm.

FLEX

ADO design

HIERRO • CORTEN • INOX. | IRON • CORTEN • STAINLESS STEEL



Banco / Bench Silla / Chair



BFLEXG01



SFLEXG01

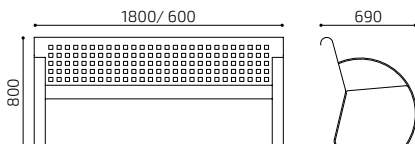

Medidas: mm.
Measures: mm.

FASO

ADO design

HIERRO • CORTEN • INOX. | IRON • CORTEN • STAINLESS STEEL



Banco / Bench Silla / Chair

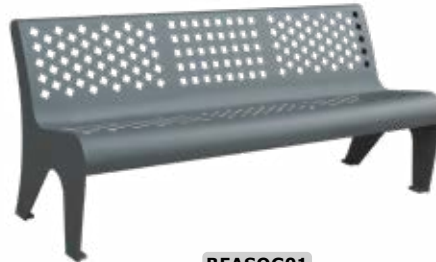

BFASOG01



SFASOG01

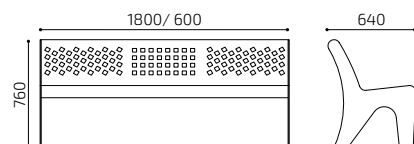

Medidas: mm.
Measures: mm.

BOOK

MADERA • CORTEN • INOX. | WOOD • CORTEN • STAINLESS STEEL

Banco / Bench Silla / Chair Banqueta / Low bench



BBOOKC02

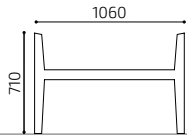

* Sin respaldo / Backless.

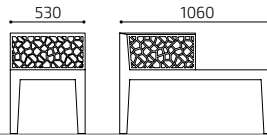

* Con respaldo / With Backup.

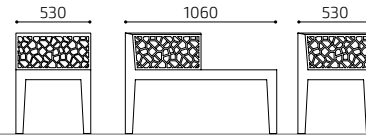

* Con 2 respaldos / With 2 Backs.

Medidas: mm.
Measures: mm.

GARDEN

MADERA • HIERRO • CORTEN • INOX. | WOOD • IRON • CORTEN • STAINLESS STEEL

Mesa picnic / Picnic table



BGARDENG01



Madera
Wood



Chapa
Sheet



Hierro
Iron

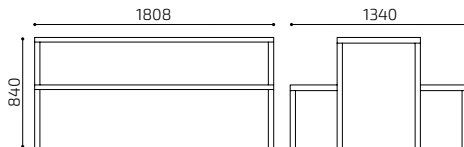

Medidas: mm.
Measures: mm.

PICNIC

MADERA • HIERRO • CORTEN • INOX. | WOOD • IRON • CORTEN • STAINLESS STEEL

Mesa picnic / Picnic table



BPICNICG01



Madera
Wood



Hierro
Iron

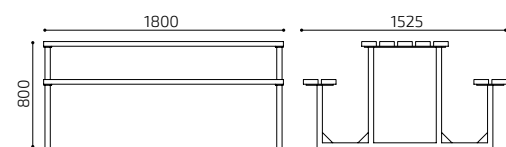

Medidas: mm.
Measures: mm.

STRONG

MADERA • HIERRO • CORTEN • INOX. | WOOD • IRON • CORTEN • STAINLESS STEEL

Mesa picnic / Picnic table



BSTRONG01



Madera
Wood



Hierro
Iron

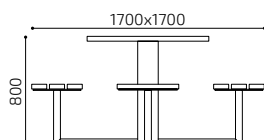

Medidas: mm.
Measures: mm.

OCIO

MADERA • HIERRO • CORTEN • INOX. | WOOD • IRON • CORTEN • STAINLESS STEEL

Mesa picnic / Picnic table



BOCI0G01

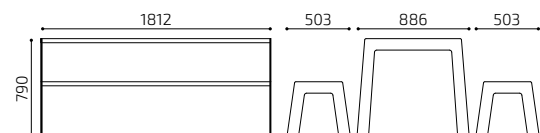

Medidas: mm.
Measures: mm.

MESAS PICNIC | PICNIC TABLES

JORVI

MADERA | WOOD

Mesa picnic / Picnic table



Picnic gama premium
Picnic premium range

JORVI

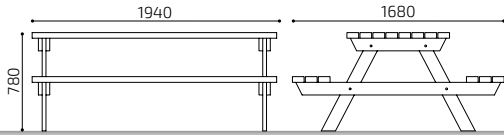

Medidas: mm.
Measures: mm.

SILVESTRE

MADERA | WOOD

Mesa picnic / Picnic table



Picnic gama eco
Picnic eco range

MSILVESTRE

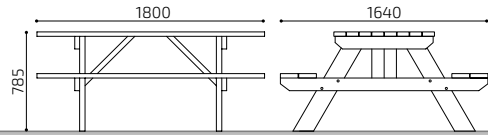

Medidas: mm.
Measures: mm.

APOYO

MADERA • HIERRO • CORTEN • INOX. | WOOD • IRON • CORTEN • STAINLESS STEEL

Banco / Bench



BAPOYOI01

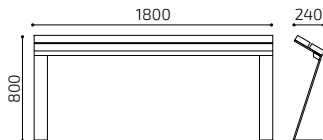

Medidas: mm.
Measures: mm.

REPOSO

HIERRO • CORTEN • INOX. | IRON • CORTEN • STAINLESS STEEL

Banco / Bench



BREPOSOG01

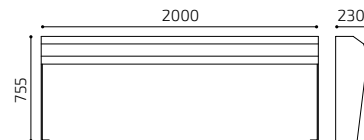

Medidas: mm.
Measures: mm.



BANCOS DE HORMIGÓN / CONCRETE BENCHES

HORMIGÓN | CONCRETE



Cube



Prisma



Trinix



DISEÑOS A MEDIDA / CUSTOMIZED DESIGNS

MADERA • HIERRO • CORTEN • INOX. | WOOD • IRON • CORTEN • STAINLESS STEEL







Escanear código QR ver en web / Scan the QR code to see on web



Ver todos los modelos en la web / See all models on the web



APARCABICICLETAS / APARCAPATINETES

BICYCLE PARKING /
SCOOTER RACKS

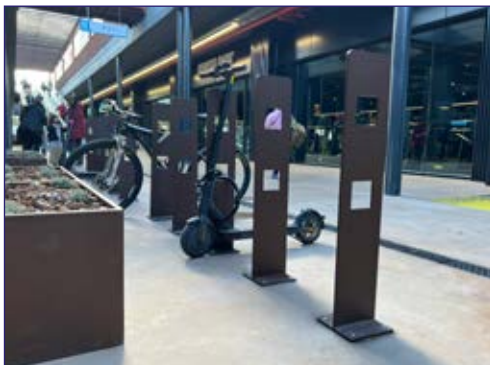
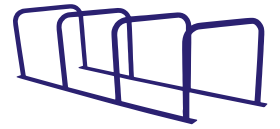

UNIVERSAL

HIERRO GALVANIZADO • CORTEN • INOX. | GALVANIZED I. • CORTEN • STAINLESS STEEL



Unidad / Unit | 2



APARCAI

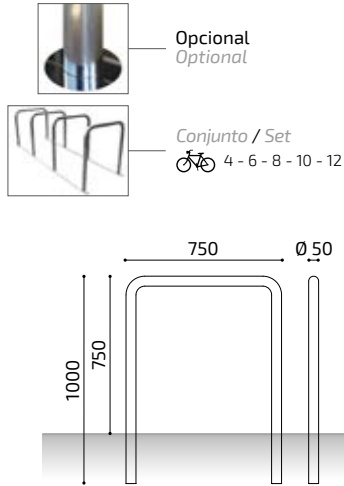

Bajo pedido AISI 316. / By request AISI 316.

ARRA

HIERRO GALVANIZADO • CORTEN • INOX. | GALVANIZED I. • CORTEN • STAINLESS STEEL



Unidad / Unit | 2



ARRAI304

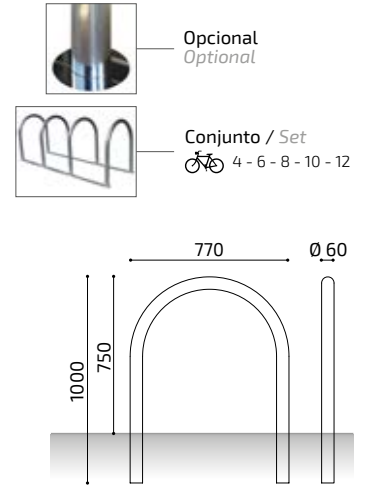

Bajo pedido AISI 316. / By request AISI 316.

ROTUL

HIERRO GALVANIZADO • CORTEN • INOX. | GALVANIZED I. • CORTEN • STAINLESS STEEL



Unidad / Unit | 2



APROTULG

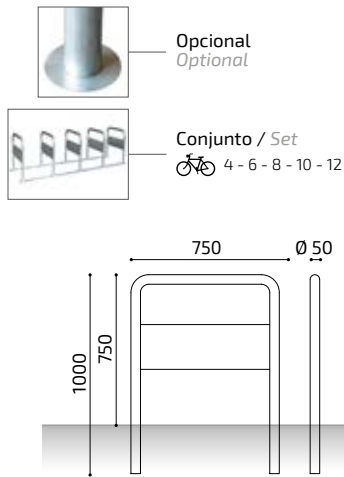

Bajo pedido AISI 316. / By request AISI 316.

PLETI

HIERRO GALVANIZADO • CORTEN • INOX. | GALVANIZED I. • CORTEN • STAINLESS STEEL



Unidad / Unit | 2



APLETIG

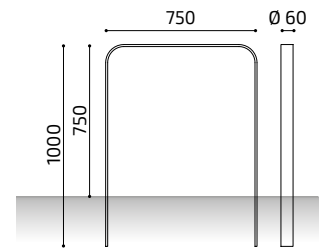

Bajo pedido AISI 316. / By request AISI 316.

MODUL

HIERRO GALVANIZADO | GALVANIZED IRON

Conjunto / Set | 6



APARCAMODULGP6

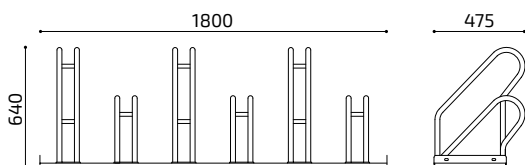

Medidas: mm.
Measures: mm.

UVE

HIERRO GALVANIZADO | GALVANIZED IRON

Conjunto / Set | 6



APARCAUVEG6

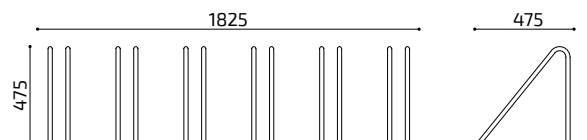

Medidas: mm.
Measures: mm.



NOR

HIERRO GALVANIZADO • INOX. | GALVANIZED I. • STAINLESS STEEL



Conjunto / Set | 6



Fijación a suelo o a pared
Fixing to floor or wall

APARCANORG6

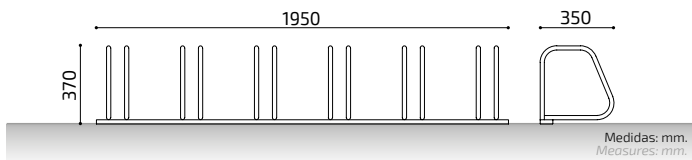

Medidas: mm.
Measures: mm.

Bajo pedido AISI 316. / By request AISI 316.

PLEC / CLEC

HIERRO • CORTEN | IRON • CORTEN STEEL



Conjunto / Set | 4



APPLECH4

APCLECH4

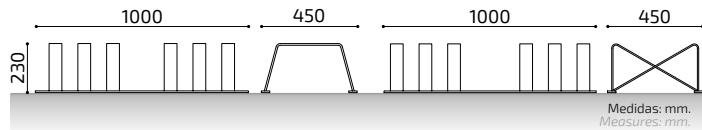

Medidas: mm.
Measures: mm.

TWISTER

H. GALVANIZADO • CORTEN | GALVANIZED I. • CORTEN



Conjunto / Set | 20



APARCATWISTEROG01

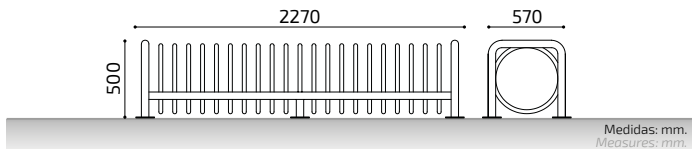

Medidas: mm.
Measures: mm.

SNAKE

H. GALVANIZADO • CORTEN • INOX. | GALVANIZED I. • CORTEN • STAINLESS STEEL



Conjunto / Set | 7



APARCASNAKEIP7

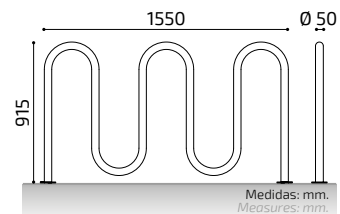

Medidas: mm.
Measures: mm.

Bajo pedido AISI 316. / By request AISI 316.

ARI

ACERO INOX. | STAINLESS STEEL



Unidad / Unit | 2



Opcional
Optional



Conjunto / Set
 4 - 6 - 8 - 10 - 12



ARI304

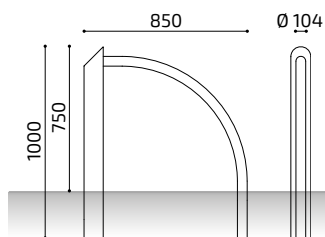

Bajo pedido AISI 316. / By request AISI 316.

OLA

ACERO INOX. | STAINLESS STEEL



Unidad / Unit | 2



Opcional
Optional



Conjunto / Set
 4 - 6 - 8 - 10 - 12



OLA1304

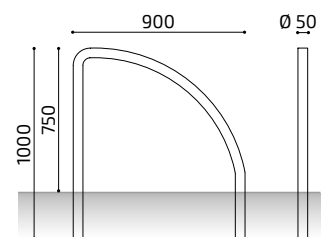

Bajo pedido AISI 316. / By request AISI 316.

TOTEM

HIERRO GALVANIZADO • CORTEN | GALVANIZED IRON • CORTEN STEEL



Unidad / Unit | 2



APTOTEMG01

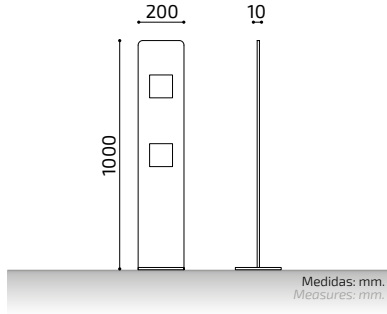

CAPE

HIERRO GALVANIZADO | GALVANIZED IRON



Unidad / Unit | 2



APCAPE01

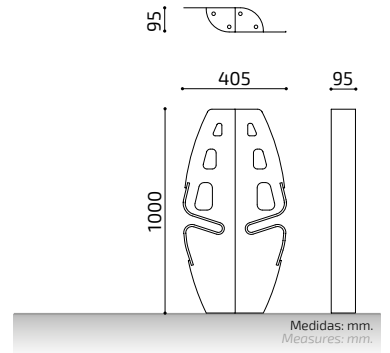

FOUR

ADO design

HIERRO GALVANIZADO • CORTEN • INOX. | GALVANIZED I. • CORTEN • STAINLESS STEEL



Unidad / Unit | 2



APARCAFOURI304P

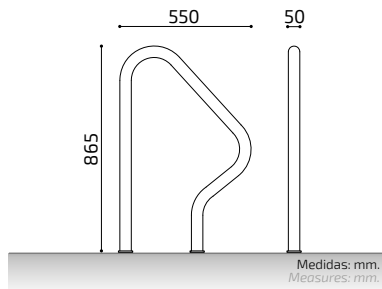

Bajo pedido AISI 316. / By request AISI 316.

URANO

H. GALVANIZADO • CORTEN • INOX. | GALVANIZED I. • CORTEN • STAINLESS STEEL



Unidad / Unit | 2



APURANOP304

APURANOCOP

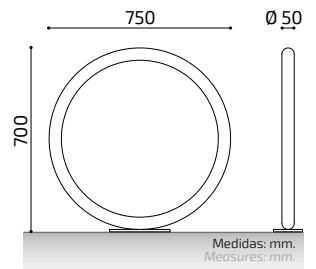

Bajo pedido AISI 316. / By request AISI 316.

NEPTUNO

H. GALVANIZADO • CORTEN • INOX. | GALVANIZED I. • CORTEN • STAINLESS STEEL



Unidad / Unit | 2



APNEPTUNOP304

APNEPTUNOCOP

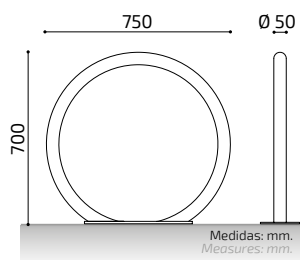

Bajo pedido AISI 316. / By request AISI 316.

VILA

H. GALVANIZADO • CORTEN • HIERRO | GALVANIZED I. • CORTEN • IRON



Unidad / Unit | 2



APVILAG01

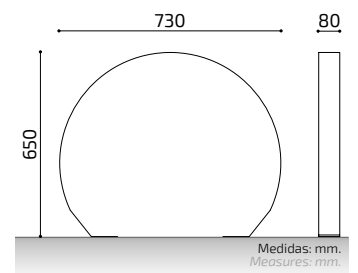

Bajo pedido AISI 316. / By request AISI 316.

PARÍS / MARSELLA

HIERRO • CORTEN | IRON • CORTEN STEEL



Unidad / Unit | 1



APBPRO

APBMCO

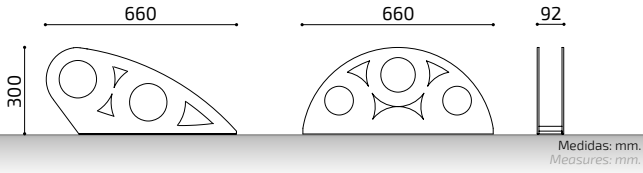

LETTER

ADO design

H. GALVANIZADO • CORTEN • INOX. | GALVANIZED I. • CORTEN • STAINLESS STEEL



Conjunto / Set | 8

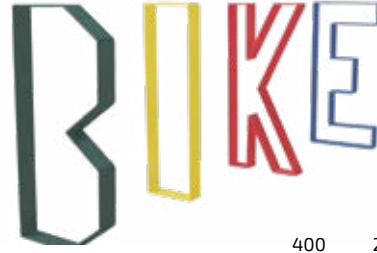

Letras según diseño
Custom Lettering

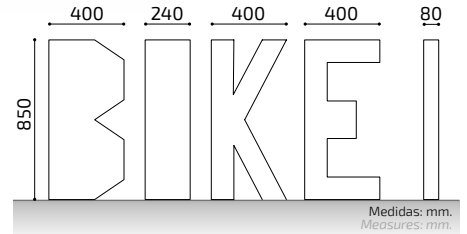

Taquilla aparca bicicletas plegables / patinetes

Folding bike and scooter parking locker

CAGE

HIERRO | IRON



TAQBICI



Cerradura codificada por contraseña electrónica digital de apertura-cierre mediante combinación numérica.
Lock coded by digital electronic password for opening-closing by means of a numerical combination.

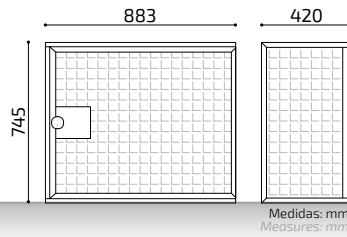

BIKE

ADO design

HIERRO GALVANIZADO • CORTEN • ACERO INOX. | GALVANIZED IRON • CORTEN STEEL • STAINLESS STEEL



APARCABIKEI304P



APARCABIKEI304P2



APARCABIKEI304P4

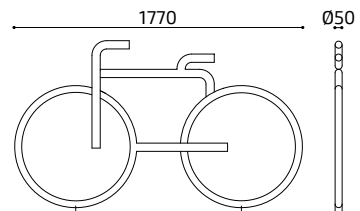
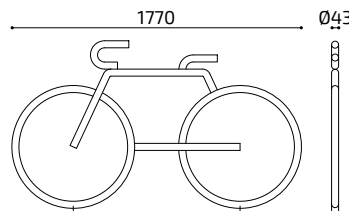
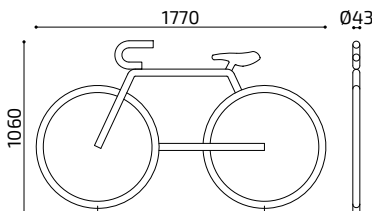

Medidas: mm.
Measures: mm.

Bajo pedido AISI 316. / By request AISI 316.

Estación mantenimiento Bicicletas

Bike repair station

KEEPER

ACERO INOXIDABLE • HIERRO | STAINLESS STEEL • IRON

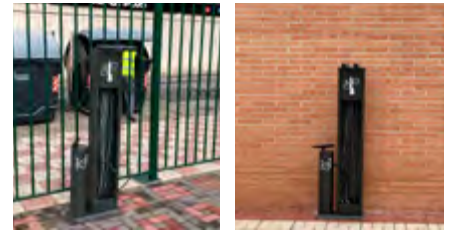

KEEPERI04

KEEPERG03

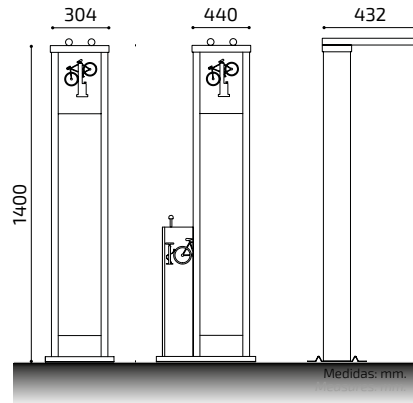

FLOOR

HIERRO | IRON



Unidad / Unit | 1

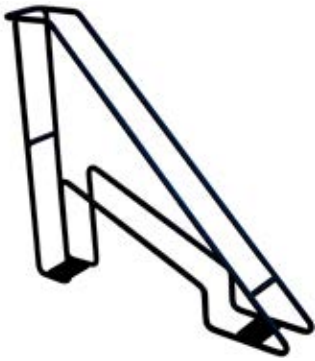

AFLOORHN

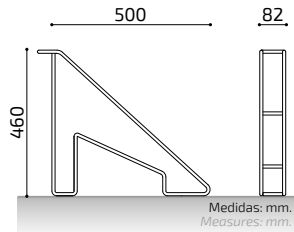

WALL

HIERRO | IRON



Unidad / Unit | 1



AWALLHN

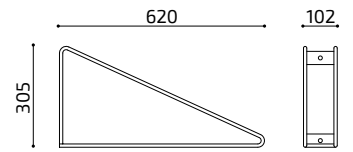

Soporte Suelo | Floor Bracket

FOREST

HIERRO + MADERA | IRON + WOOD

ADO design



AFORESTHR

AFORESTHN

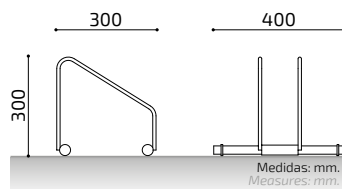

Soporte Pared | Wall Bracket

KONG

HIERRO | IRON



KONGBR01

KONGGN01

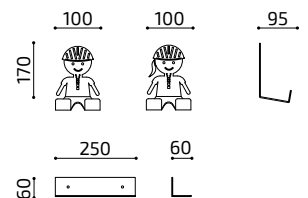

E-SCOOTER

HIERRO GALVANIZADO • INOX. | GALVANIZED IRON • STAINLESS STEEL



5 - 8 - 11



A	B	C
1000	200	900
1500	200	900
1900	200	900

APSCOOTERG2.0PE

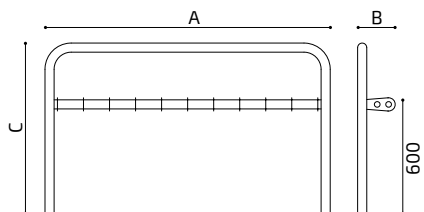

Medidas: mm.
Measures: mm.

Bajo pedido AISI 316. / By request AISI 316.

E-SCHOOL

HIERRO GALVANIZADO • INOX. | GALVANIZED IRON • STAINLESS STEEL



4 - 7 - 10



A	B	C
1000	200	600
1500	200	600
1900	200	600

APSCHOOLG1.5PE

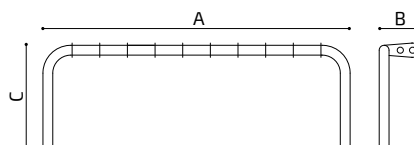

Medidas: mm.
Measures: mm.

Bajo pedido AISI 316. / By request AISI 316.

E-SKATER

HIERRO GALVANIZADO • INOX. | GALVANIZED IRON • STAINLESS STEEL



6 - 9 - 11



A	B	C
1000	230	900
1500	230	900
1900	230	900

APSKATERG1.5PE

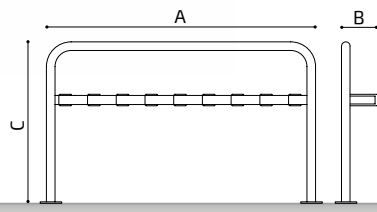

Medidas: mm.
Measures: mm.

Bajo pedido AISI 316. / By request AISI 316.

E-ROLLER

HIERRO GALVANIZADO • INOX. | GALVANIZED IRON • STAINLESS STEEL



5 - 8 - 10



A	B	C
1000	230	600
1500	230	600
1900	230	600

APROLLERG1.5PE

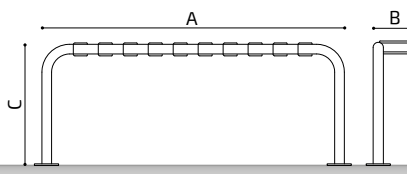

Medidas: mm.
Measures: mm.

Bajo pedido AISI 316. / By request AISI 316.

E-NUMBER

HIERRO GALVANIZADO • INOX. | GALVANIZED IRON • STAINLESS STEEL



4 - 6 - 8



Cerradura codificada por contraseña electrónica digital de apertura-cierre mediante combinación numérica.

Lock coded by digital electronic password for opening-closing by means of a numerical combination.

A	B	C
1000	150	900
1500	150	900
1900	150	900

APNUMBERG2.0PE

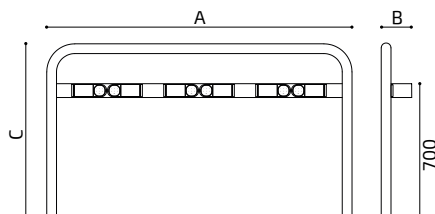

Medidas: mm.
Measures: mm.

Bajo pedido AISI 316. / By request AISI 316.







Escanear código QR ver en web / Scan the QR code to see on web



Ver todos los modelos en la web / See all models on the web



PAPELERAS / CENICEROS

LITTER BINS | ASHTRAYS

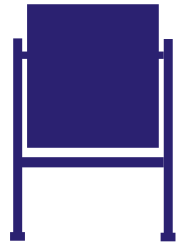

CIRCU

HIERRO • ACERO INOX. | IRON • STAINLESS STEEL

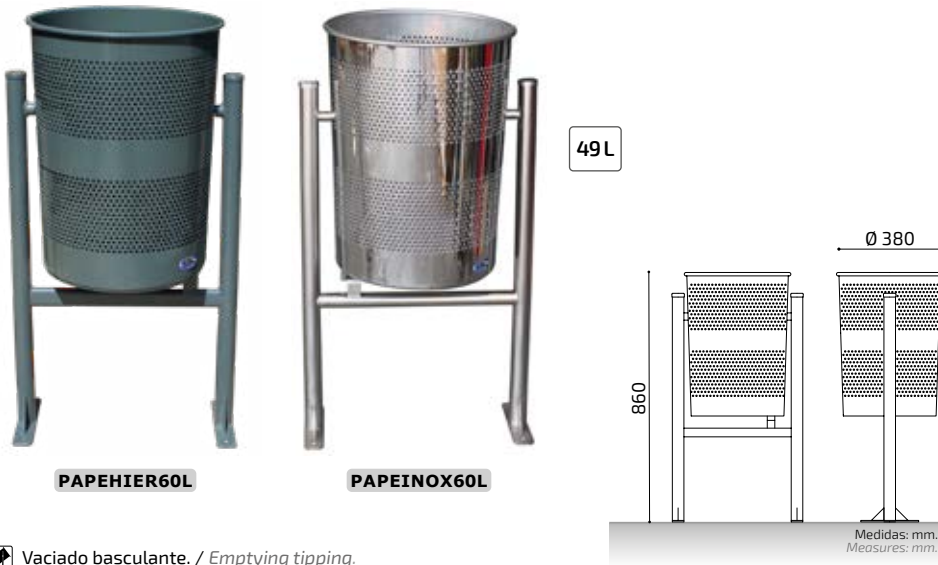

☑ Vaciado basculante. / Emptying tipping.

SEMICIRCU

HIERRO • ACERO INOX. | IRON • STAINLESS STEEL

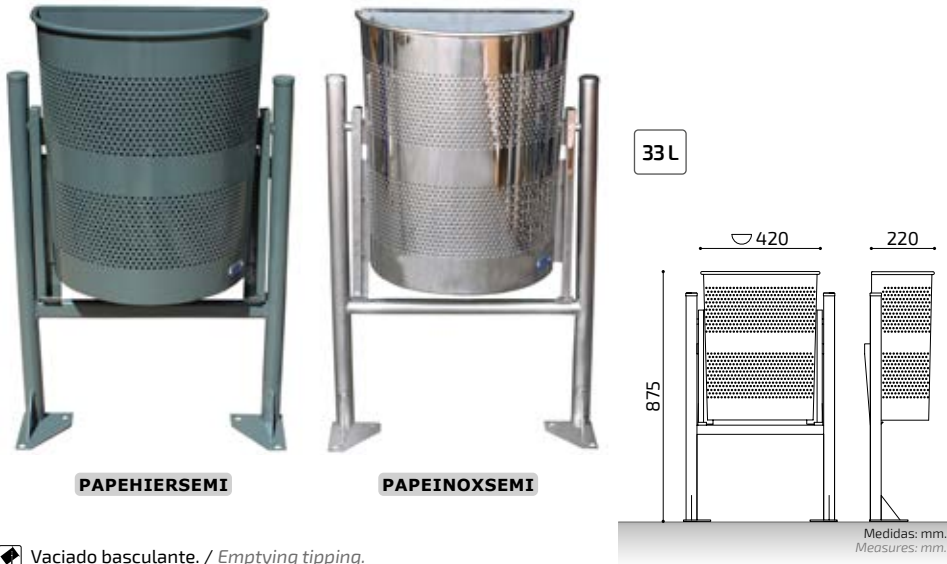

☑ Vaciado basculante. / Emptying tipping.

BARCELONA / BARCELONA DOBLE

HIERRO | IRON

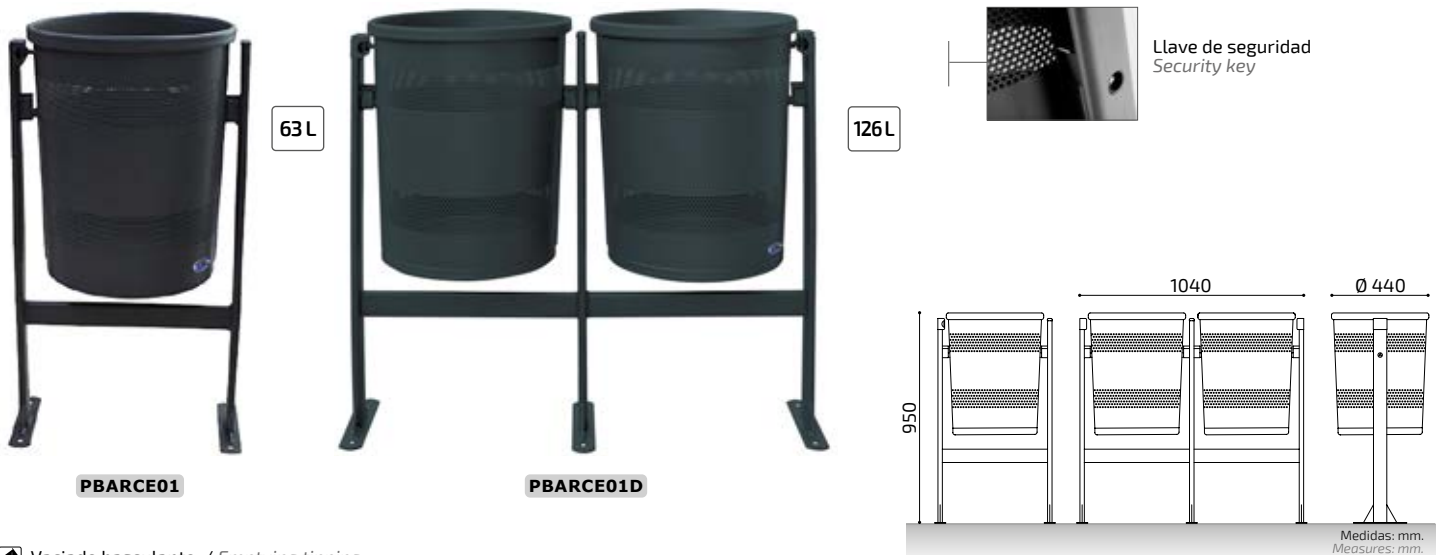

☑ Vaciado basculante. / Emptying tipping.

LIFE

HIERRO | IRON



47L

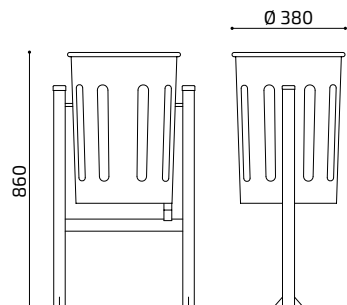

Medidas: mm.
Measures: mm.

PLIFE01

☑ Vaciado basculante. / Emptying tipping.

TENE

HIERRO | IRON



38L

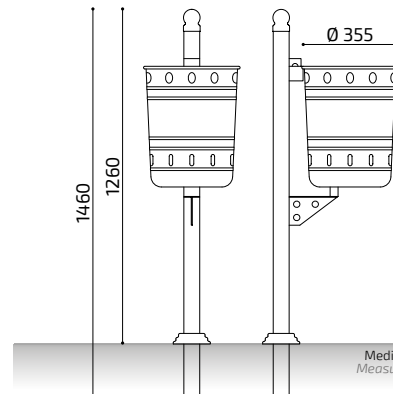

Medidas: mm.
Measures: mm.

PTENE01

☑ Vaciado basculante. / Emptying tipping.

DIM

HIERRO • CORTEN • INOX. | IRON • CORTEN STEEL • STAINLESS STEEL



50L

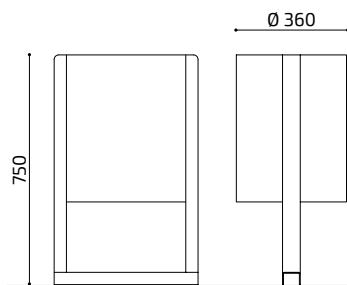

Medidas: mm.
Measures: mm.

PDIMIG01

RETO

HIERRO • CORTEN • INOX. | IRON • CORTEN STEEL • STAINLESS STEEL



50L

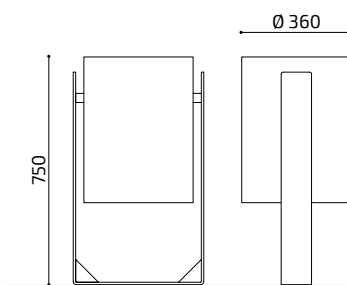

Medidas: mm.
Measures: mm.

PRETO01

☑ Vaciado basculante. / Emptying tipping.

TALI

HIERRO • CORTEN • INOX. | IRON • CORTEN STEEL • STAINLESS STEEL



42L

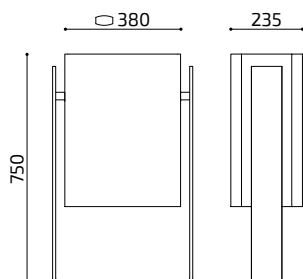

Medidas: mm.
Measures: mm.

PTALIIC

☑ Vaciado basculante. / Emptying tipping.

TALI PLUS

HIERRO • CORTEN • INOX. | IRON • CORTEN STEEL • STAINLESS STEEL



33L

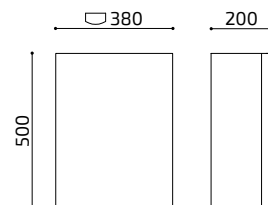

PTALIPI

Fijación a pared. / Fixing to wall.

SIME

HIERRO • CORTEN • INOX. | IRON • CORTEN STEEL • STAINLESS STEEL



Opcional: Cenicero
Optional: Ashtray

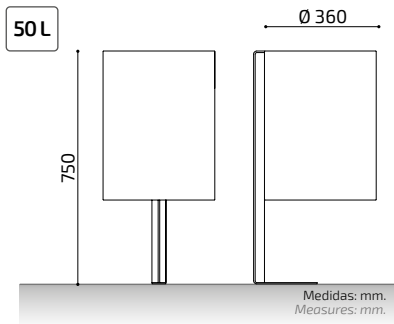

PSIMEC01

TRESTO

HIERRO • CORTEN • INOX. | IRON • CORTEN STEEL • STAINLESS



Opcional: Cenicero
Optional: Ashtray

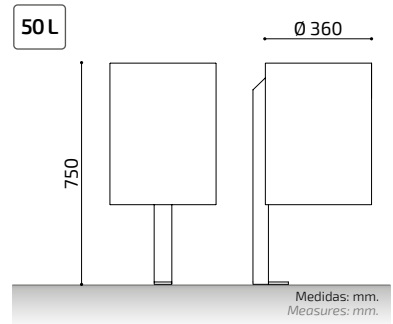

PTRESTO01

MALLEN

HIERRO • CORTEN • INOX. | IRON • CORTEN STEEL • STAINLESS



Opcional: Cenicero
Optional: Ashtray

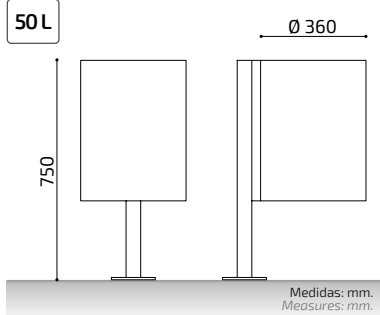

PMALLENC01

LUXOR

HIERRO • CORTEN | IRON • CORTEN STEEL



50 L

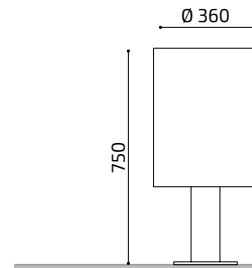

PLUXORC01

TRECEN

HIERRO • CORTEN | IRON • CORTEN STEEL



50 L

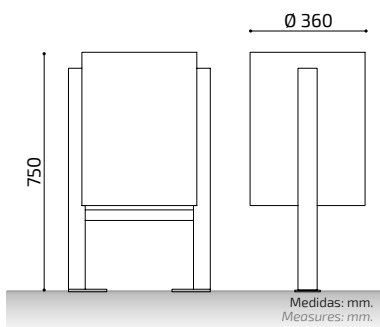

PTRECENC01

RUE

HIERRO • CORTEN | IRON • CORTEN STEEL



50 L

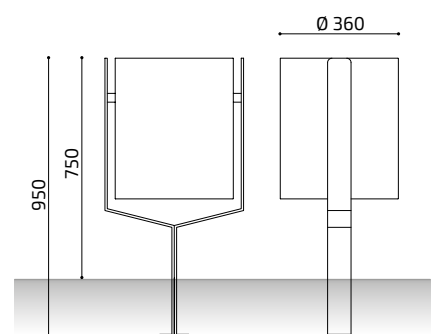

PRUEC01

DEVA ADO design

HIERRO • CORTEN • INOX. | IRON • CORTEN STEEL • STAINLESS STEEL



92 L

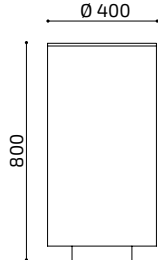

PDEVAG01

Medidas: mm.
Measures: mm.

NOK ADO design

HIERRO GALVANIZADO | GALVANIZED IRON



Opcional: Cubeta interior
Optional: Interior bucket

120 L

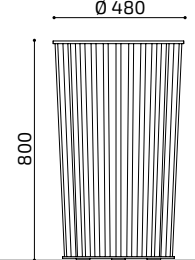

PNOKG01

Medidas: mm.
Measures: mm.

BEE ADO design

HIERRO GALVANIZADO • CORTEN | GALVANIZED IRON • CORTEN STEEL



87 L

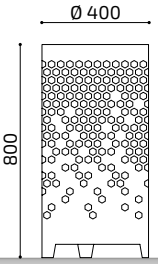

PBEEG01

Medidas: mm.
Measures: mm.



Opcional: Cubeta interior
Optional: Interior bucket

STONE ADO design

HIERRO • CORTEN | IRON • CORTEN STEEL



87 L

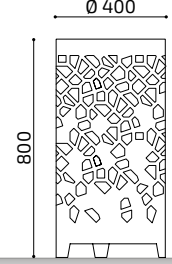

PSTONEC01

Medidas: mm.
Measures: mm.



Opcional: Cubeta interior
Optional: Interior bucket

LIVRE ADO design

H. GALVANIZADO • CORTEN • INOX. | GALVANIZED I. • CORTEN • STAINLESS STEEL



115 L

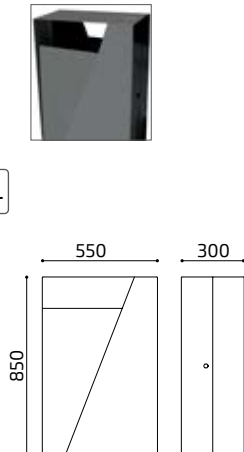

PLIVREC01

Medidas: mm.
Measures: mm.



BOITE ADO design

HIERRO • CORTEN • INOX. | IRON • CORTEN STEEL • STAINLESS STEEL



130 L

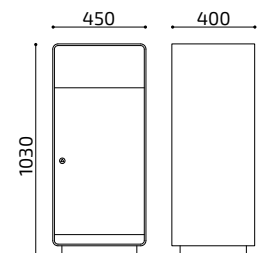

PBOITEG01

Medidas: mm.
Measures: mm.



ARCADIA

HIERRO GALVANIZADO • CORTEN | GALVANIZED IRON • CORTEN STEEL



103 L

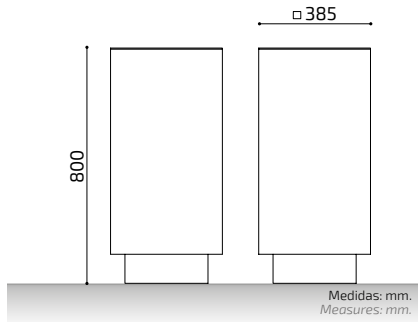

PARCADIAG01

Medidas: mm.
Measures: mm.

TEBAS

HIERRO GALVANIZADO • CORTEN | GALVANIZED IRON • CORTEN STEEL



96 L

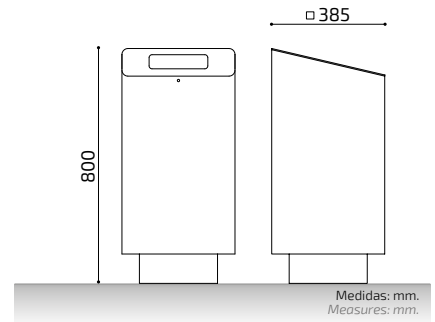

PTEBASG01

Medidas: mm.
Measures: mm.

EMI

ACERO INOX. | STAINLESS STEEL



66 L

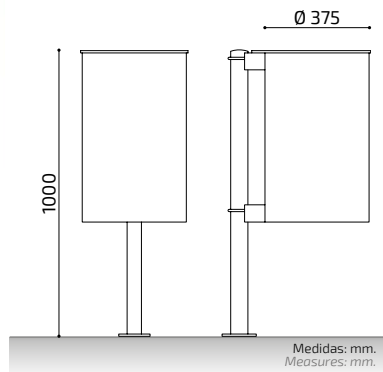

PEMI01

Medidas: mm.
Measures: mm.

DENLA

ACERO INOX. | STAINLESS STEEL



Posibilidad de anclaje a pared
Possibility of anchoring to wall

42 L

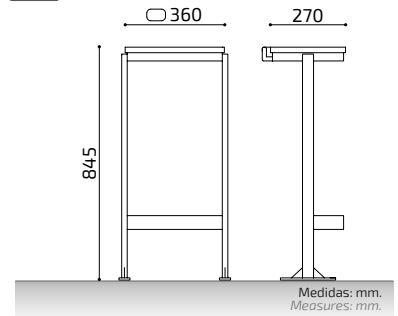

PDENLA

Medidas: mm.
Measures: mm.

Bajo pedido AISI 316. / By request AISI 316.

Bajo pedido AISI 316. / By request AISI 316.



BOX

H. GALVANIZADO • ACERO INOX. | GALVANIZED IRON • STAINLESS STEEL



Caja bolsas (10 rollos de 500 bolsas)
Bag box (10 rolls of 500 bags)
Tamaño bolsa / Bag size: 250x340
(No incluidas / Not included)

BEMUSI02

34 L

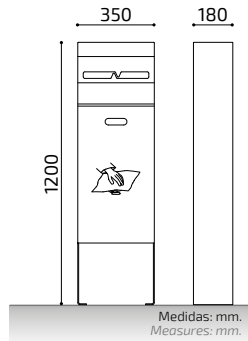

☑ Vaciado basculante. / Emptying tipping.

MUSI

H. GALVANIZADO • ACERO INOX. | GALVANIZED IRON • STAINLESS STEEL



Caja bolsas (10 rollos de 500 bolsas)
Bag box (10 rolls of 500 bags)
Tamaño bolsa / Bag size: 250x340
(No incluidas / Not included)

BEMUSI02

27 L

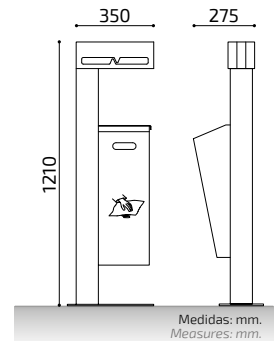

☑ Vaciado basculante. / Emptying tipping.

MINI BOX

H. GALVANIZADO • ACERO INOX. | GALVANIZED IRON • STAINLESS STEEL



34 L

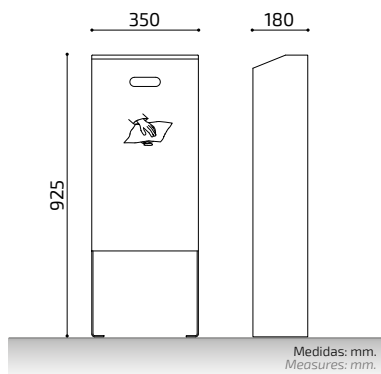

☑ Vaciado basculante. / Emptying tipping.

Dispensador Bolsas | Bag Dispenser SIMU

H. GALVANIZADO • ACERO INOX. | GALVANIZED IRON • STAINLESS STEEL



PSIMUV01



Caja bolsas (10 rollos de 500 bolsas)
Bag box (10 rolls of 500 bags)
Tamaño bolsa / Bag size: 250x340
(No incluidas / Not included)

BEMUSI02



Fijación poste o farola
Fixing pole or lamppost

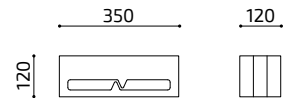

Dispensador Bolsas | Bag Dispenser PICK / AREN

ACERO INOX. | STAINLESS STEEL



DBPICKI01

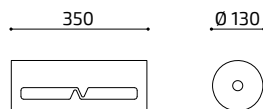

DBARENG01

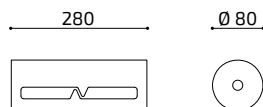

Tamaño bolsa / Bag size: 250x340
(No incluidas / Not included)

BEMUSI02

Bajo pedido AISI 316. / By request AISI 316.

Dispensador Bolsas | Bag Dispenser BAG

ACERO INOX. | STAINLESS STEEL



DBBAGI01



Caja bolsas (10 rollos de 500 bolsas)
Bag box (10 rolls of 500 bags)
Tamaño bolsa / Bag size: 250x340
(No incluidas / Not included)

BEMUSI02

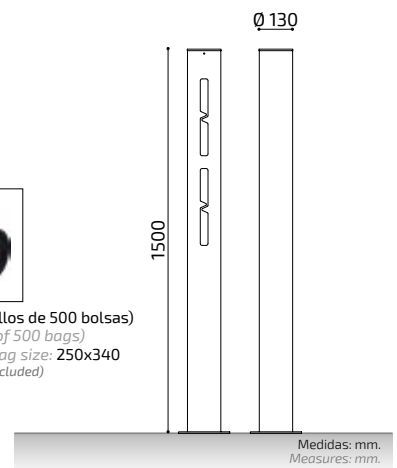

Bajo pedido AISI 316. / By request AISI 316.

Ceniceros | Ashtrays LILLA

HIERRO • ACERO INOX. | IRON • STAINLESS STEEL



CLILLA01

CLILLAG01

CLILLALG01



Detalle apertura inferior
Lower opening

Cenicero | Ashtray ROU

H. GALVANIZADO • CORTEN + INOX. | GALVANIZED / CORTEN • STAINLESS STEEL

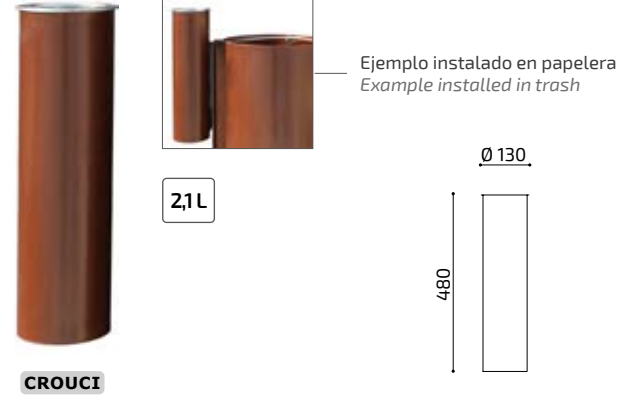

CROUCI

Cenicero | Ashtray KESMO

HIERRO | IRON

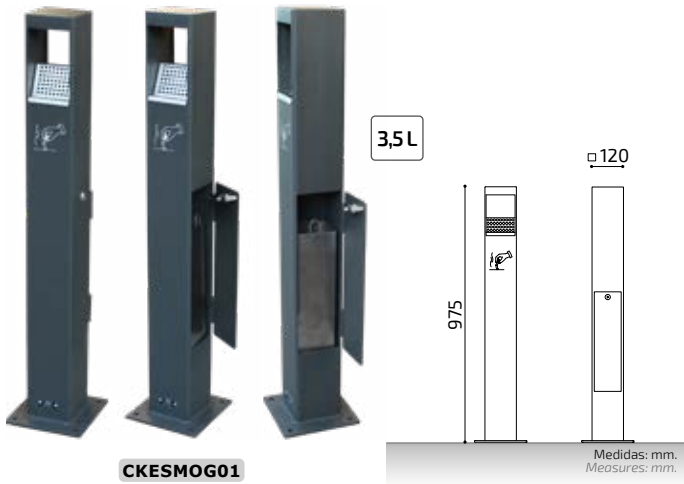

CKESMOG01

Cenicero | Ashtray FUMI

GALVANIZADO | GALVANIZED

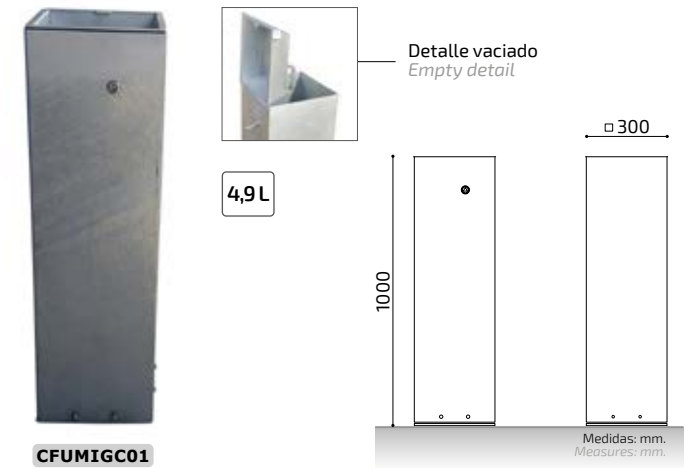

CFUMIGC01





Escanear código QR ver en web / Scan the QR code to see on web



Ver todos los modelos en la web / See all models on the web



FUENTES DUCHAS / LAVAPIES

FOUNTAINS SHOWERS / FOOT WASHERS



DROP

PLASTICO RECICLADO • RECYCLED PLASTIC



FDROP01

RFP01

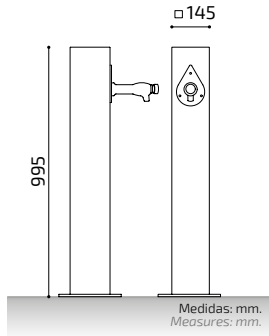

Medidas: mm.
Measures: mm.

PRISMA

PLASTICO RECICLADO • RECYCLED PLASTIC



FUCU01

RFP01

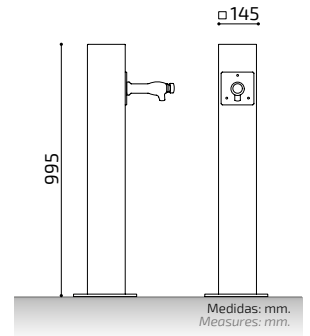

Medidas: mm.
Measures: mm.

FOX

PLASTICO RECICLADO • RECYCLED PLASTIC



FFOX01

RFP01

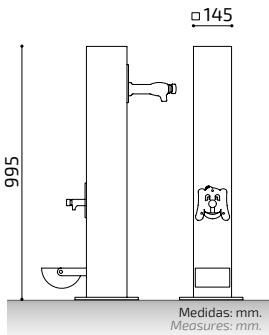

Medidas: mm.
Measures: mm.

VERNAL

PLASTICO RECICLADO • RECYCLED PLASTIC



FVERNAL01

RFP01

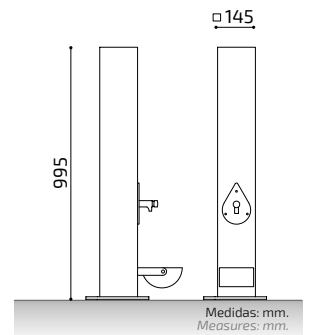

Medidas: mm.
Measures: mm.

PUG

PLASTICO RECICLADO • RECYCLED PLASTIC



FPUG01

RFP01

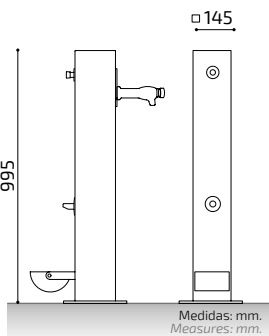

Medidas: mm.
Measures: mm.

NEVADA

PLASTICO RECICLADO • RECYCLED PLASTIC



FNEVADA01

RFP01

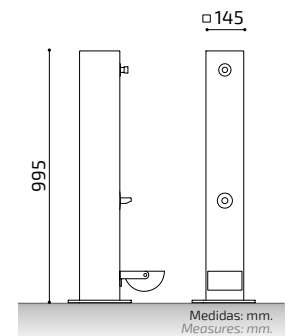

Medidas: mm.
Measures: mm.

EAU

HIERRO + INOX. | IRON + STAINLESS STEEL



FEAU01

FEAU02

Modelos
Models

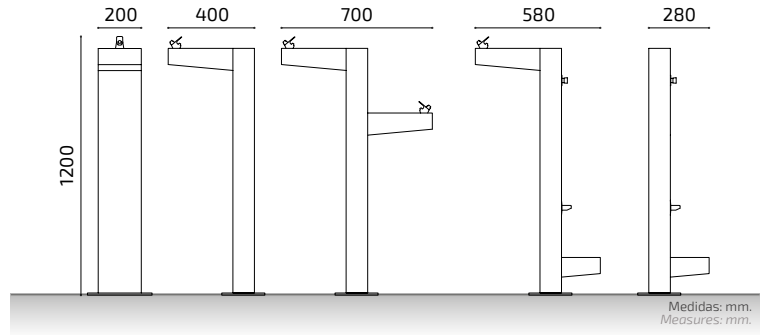

Opción gama económica (sin placa). / Economic option (without plate).

NIAGARA

HIERRO • CORTEN • INOX. | IRON • CORTEN • STAINLESS STEEL



MODELO PATENTADO
PATENTED MODEL



VICTORIA

HIERRO • CORTEN • INOX. | IRON • CORTEN • STAINLESS STEEL

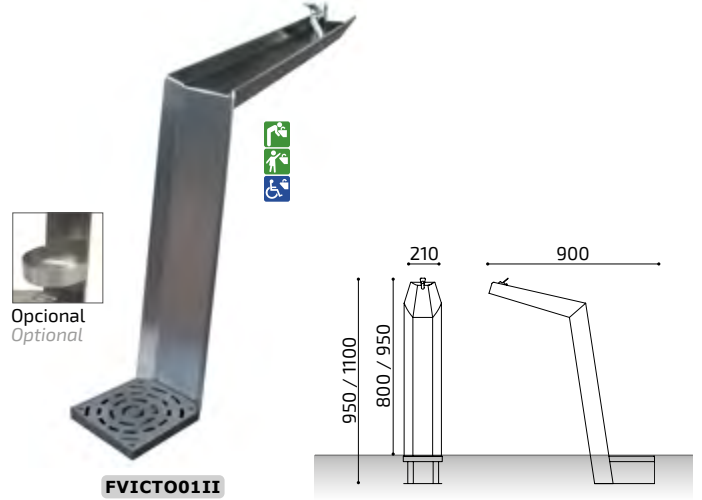

COR

HIERRO • CORTEN • INOX. | IRON • CORTEN • STAINLESS STEEL

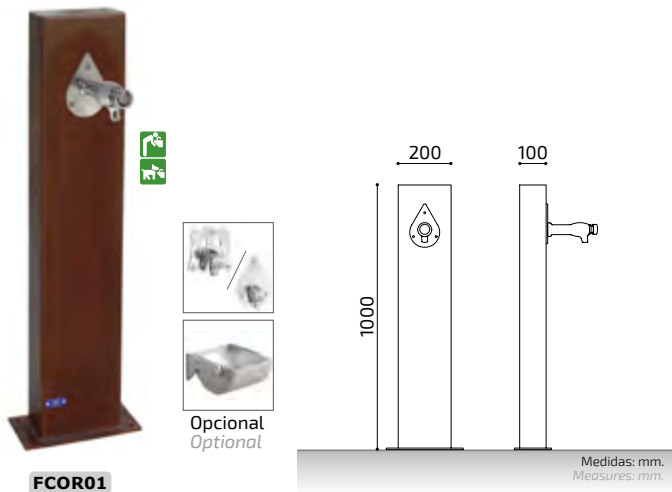

NILO

HIERRO • CORTEN • INOX. | IRON • CORTEN • STAINLESS STEEL

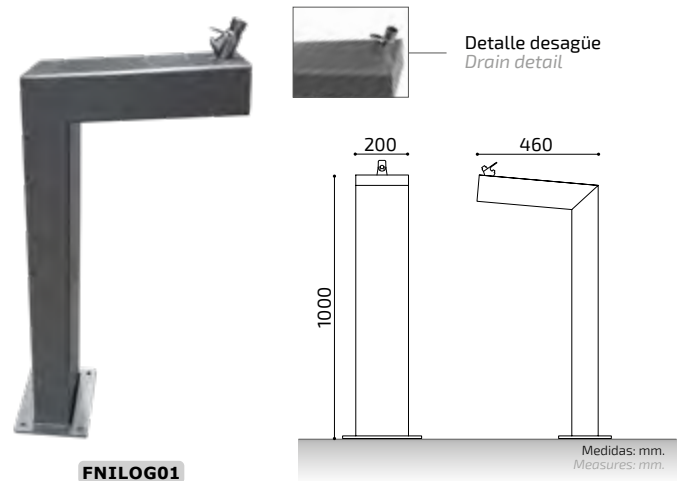

Opción gama económica (sin placa). / Economic option (without plate).

GOTA

HIERRO • CORTEN • INOX. | IRON • CORTEN • STAINLESS STEEL



FGOTAG02



Opción Eco
Eco option

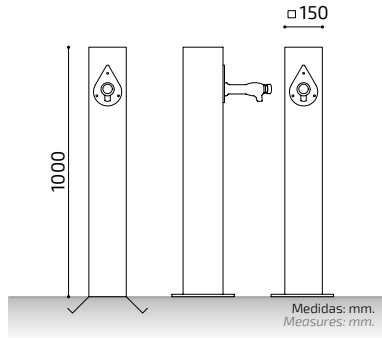

150

1000

Medidas: mm.
Measures: mm.

Opción gama económica (sin placa). / Economic option (without plate).

SQUARE

HIERRO • CORTEN • INOX. | IRON • CORTEN • STAINLESS STEEL



FUCU01



Opción Eco
Eco option

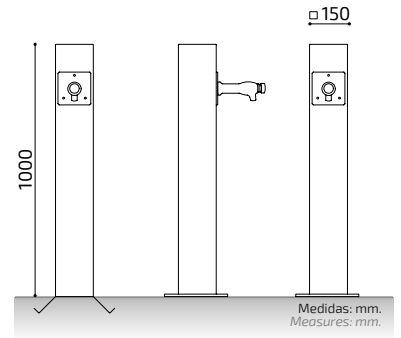

150

1000

Medidas: mm.
Measures: mm.

Opción gama económica (sin placa). / Economic option (without plate).

DOG1

HIERRO • CORTEN • INOX. | IRON • CORTEN • STAINLESS STEEL



FDOGIG02



Opción Eco
Eco option

MODELO PATENTADO
PATENTED MODEL

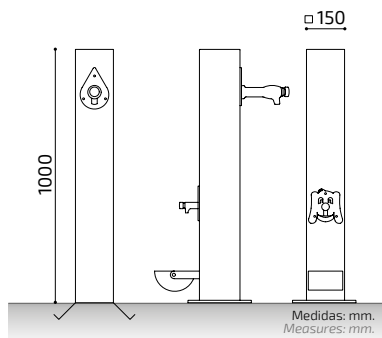

150

1000

Medidas: mm.
Measures: mm.

Opción gama económica (sin placa). / Economic option (without plate).

PUPPY

HIERRO • CORTEN • INOX. | IRON • CORTEN • STAINLESS STEEL



FPUPPY01



Opción Eco
Eco option

MODELO PATENTADO
PATENTED MODEL

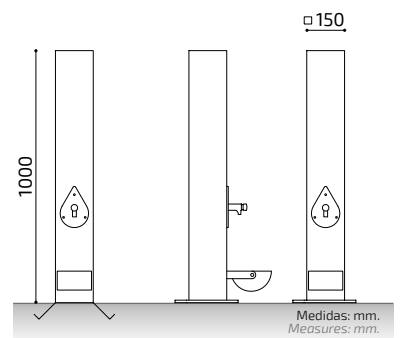

150

1000

Medidas: mm.
Measures: mm.

Opción gama económica (sin placa). / Economic option (without plate).

CANINE

HIERRO • CORTEN • INOX. | IRON • CORTEN • STAINLESS STEEL



FCANINE01



Opción Eco
Eco option

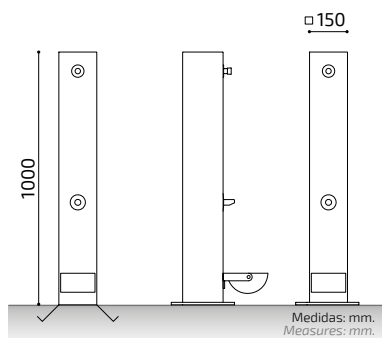

150

1000

Medidas: mm.
Measures: mm.

Opción gama económica (sin placa). / Economic option (without plate).

CIRCLE

HIERRO • CORTEN • INOX. | IRON • CORTEN • STAINLESS STEEL



FUCI01



Opción Eco
Eco option

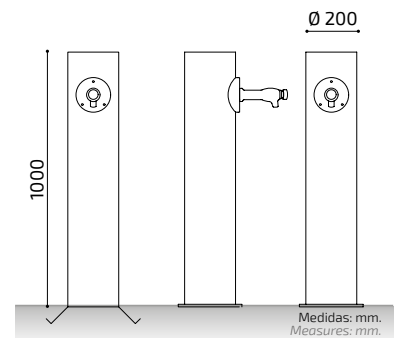

Ø 200

1000

Medidas: mm.
Measures: mm.

Opción gama económica (sin placa). / Economic option (without plate).

COMBI

HIERRO • CORTEN • INOX. | IRON • CORTEN • STAINLESS STEEL

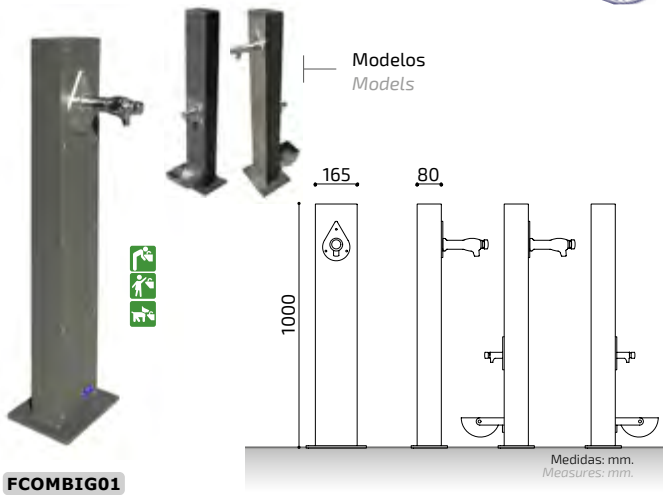

FCOMBIG01

📏 Opción gama económica (sin placa). / *Economic option (without plate).*

RIN

HIERRO • CORTEN • INOX. | IRON • CORTEN • STAINLESS STEEL

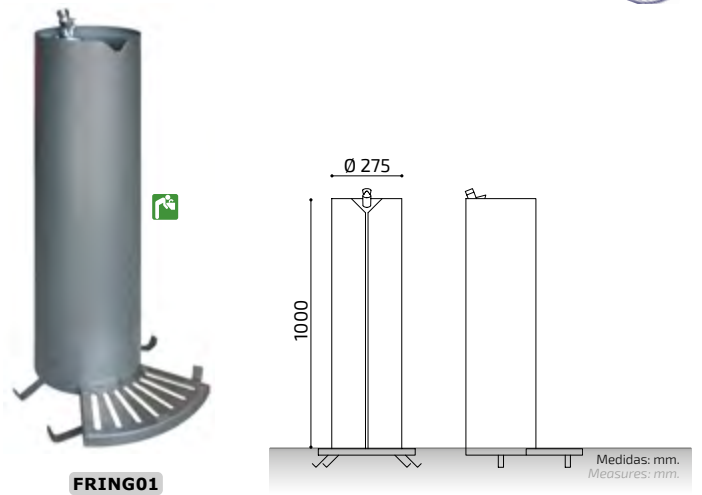

FRING01

📏 Opción gama económica (sin placa). / *Economic option (without plate).*



Accesorios | Accessories REJILLAS / FOUNTAIN GRATES

HIERRO GALVANIZADO • INOX. | GALVANIZED IRON • STAINLESS STEEL

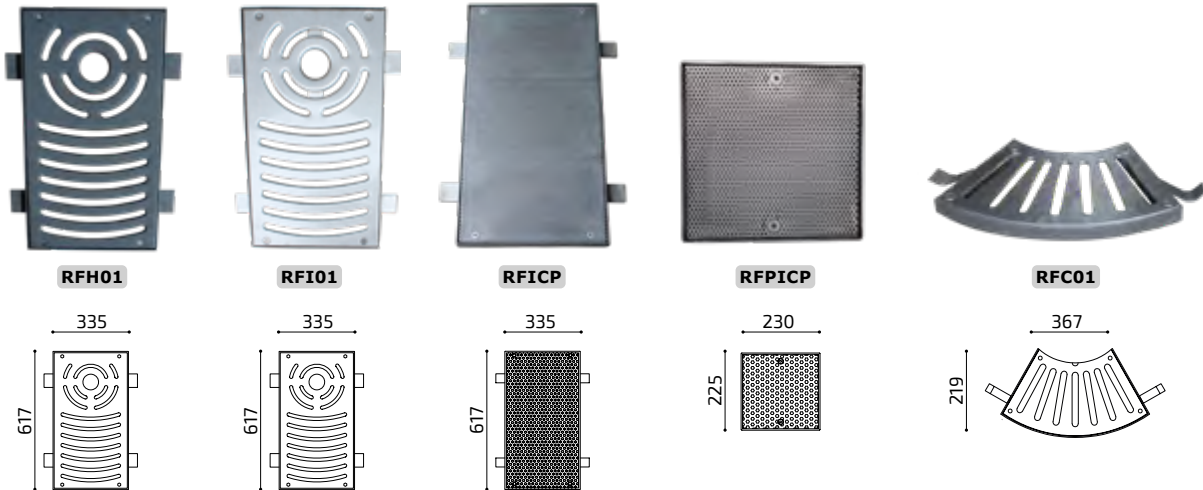

RFH01

RFI01

RFICP

RFPICP

RFC01



Accesorios | Accessories GRIFOS / TAPS

ACERO INOXIDABLE | STAINLESS STEEL



Pulsadores / Push buttons



Bebedores / Water troughs

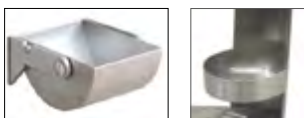

PACIFIC

ACERO INOX. • CORTEN | STAINLESS STEEL • CORTEN STEEL

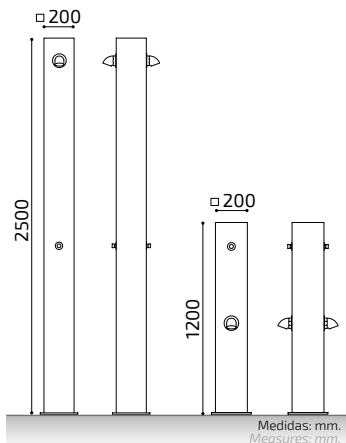

DPACIFICB03 **LPACIFICB04**

Bajo pedido AISI 316.
By request AISI 316.

1 a 4 Rociadores.
1 to 4 Sprinkler.

1 a 4 Pulsadores.
1 to 4 Push-buttons.

ARTIC

ACERO INOX. • CORTEN | STAINLESS STEEL • CORTEN STEEL

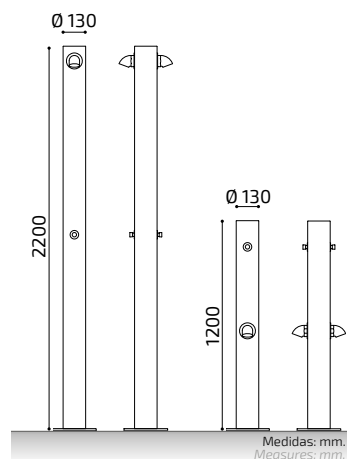

DARTICB02 **LARTICB01**

Bajo pedido AISI 316.
By request AISI 316.

1 a 2 Rociadores.
1 to 2 Sprinkler.

1 a 2 Pulsadores.
1 to 2 Push-buttons.

INDIC

ACERO INOX. • CORTEN | STAINLESS STEEL • CORTEN STEEL

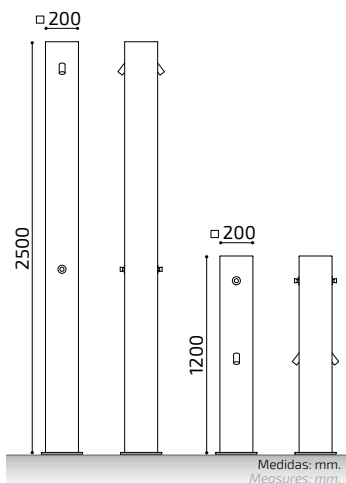

DINDICB01

LINDICB04

Bajo pedido AISI 316.
By request AISI 316.

1 a 4 Rociadores.
1 to 4 Sprinkler.

1 a 4 Pulsadores.
1 to 4 Push-buttons.

ATLANTIC

ACERO INOX. • CORTEN | STAINLESS STEEL • CORTEN STEEL

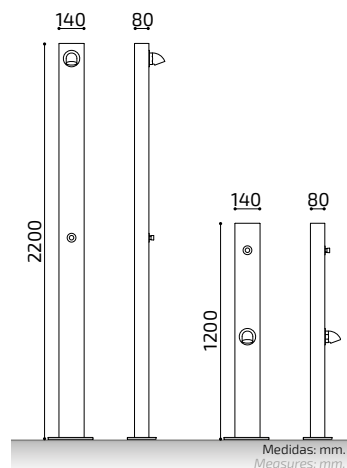

DATLANTICB01

LATLANTICB01

Bajo pedido AISI 316.
By request AISI 316.

1 Rociador.
1 Sprinkler

1 Pulsador.
1 Push-buttons.

OCEANIC

ACERO INOX. • CORTEN | STAINLESS STEEL • CORTEN STEEL

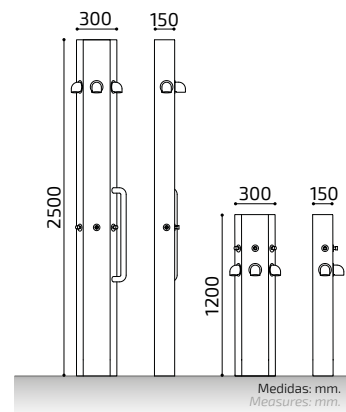

DOCEANICM03

LOCEANICM03

Bajo pedido AISI 316.
By request AISI 316.

1 a 3 Rociadores.
1 to 3 Sprinkler.

1 a 3 Pulsadores.
1 to 3 Push-buttons.

WIN

MADERA + ACERO INOX. | WOOD + STAINLESS STEEL

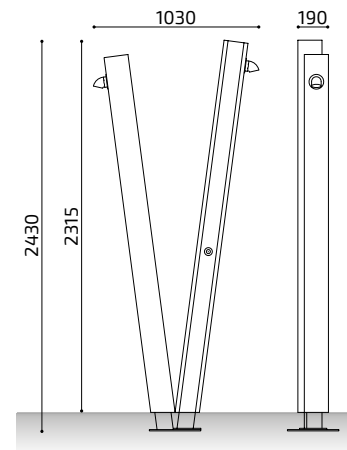

DWIN316I

Bajo pedido AISI 316.
By request AISI 316.

2 Rociadores.
2 Sprinkler.

2 Pulsadores.
2 Push-buttons.

SHOWY

HIERRO • CORTEN • ACERO INOX. | IRON • CORTEN STEEL • STAINLESS STEEL

MODELO PATENTADO
PATENTED MODEL

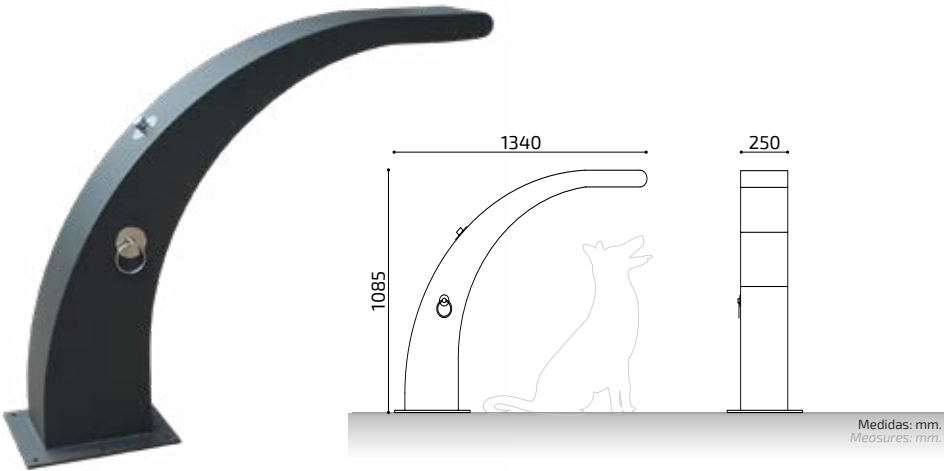

DSHOWY01G

1 Rociador. / 1 Sprinkler. 1 Pulsador. / 1 Push-button.



TARIMAS | PLATFORMS

MADERA | WOOD



TAMADUCHA

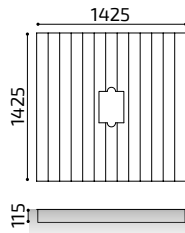

TAMAWINV

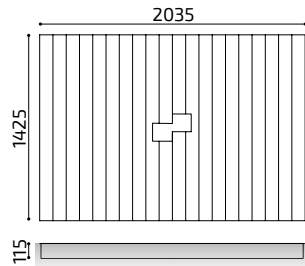

BANQUETAS | BENCHES

ACERO INOXIDABLE | STAINLESS STEEL



TABRIG001



BOCEANIS



SISTEMAS DRENANTES / BASE ANTIDESLIZANTE

DRAIN SYSTEM

HORMIGÓN | CONCRETE







JARDINERAS

FLOWER PLANTERS

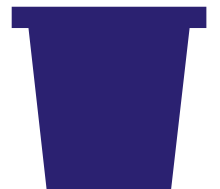

FUJI

HIERRO GALVANIZADO • CORTEN | GALVANIZED IRON • CORTEN STEEL



-  Galvanizado
Galvanized iron
-  Acero corten
Corten steel
-  Imitación corten
Corten steel imitation

Fácil transporte
Easy transport



JFUJI10

A	B	C
990	990	460
490	490	460
990	990	950
990	490	460
990	490	950

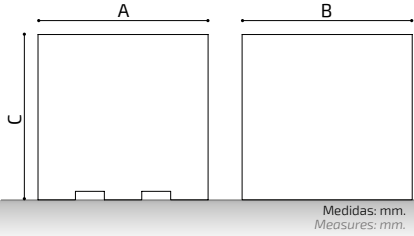

Medidas: mm.
Measures: mm.

 Opcional Hidrojardinería.
Optional Hidroplanter.

ACER

HIERRO GALVANIZADO • CORTEN | GALVANIZED IRON • CORTEN STEEL



-  Galvanizado
Galvanized iron
-  Acero corten
Corten steel
-  Imitación corten
Corten steel imitation

JACERO1

A	B	C
990	990	980
490	490	480
990	490	480
990	490	980
990	990	480

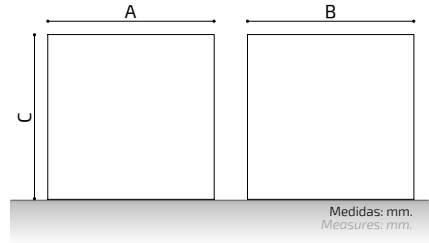

Medidas: mm.
Measures: mm.

 Opcional Hidrojardinería.
Optional Hidroplanter.

RAI

HIERRO GALVANIZADO • CORTEN | GALVANIZED IRON • CORTEN STEEL



-  Galvanizado
Galvanized iron
-  Acero corten
Corten steel
-  Imitación corten
Corten steel imitation

Transporte económico
Economic transport



JRAIC01

A	B	C
610	610	690

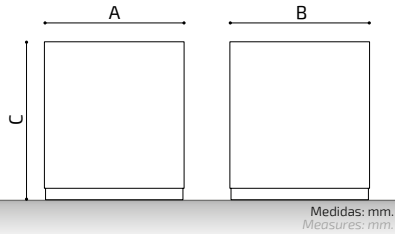

Medidas: mm.
Measures: mm.

 Opcional Hidrojardinería.
Optional Hidroplanter.

TRANSPI

HIERRO GALVANIZADO • CORTEN | GALVANIZED IRON • CORTEN STEEL



-  Galvanizado
Galvanized iron
-  Acero corten
Corten steel
-  Imitación corten
Corten steel imitation

Fácil transporte
Easy transport



Transporte económico
Economic transport



JTRANSPIC01

A	B	C
610	610	690

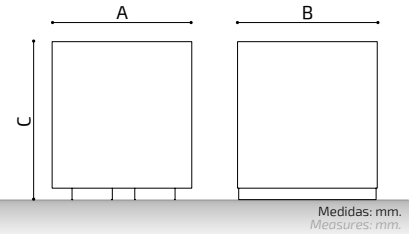

Medidas: mm.
Measures: mm.

 Opcional Hidrojardinería.
Optional Hidroplanter.

BUCAREST

HIERRO GALVANIZADO • CORTEN | GALVANIZED IRON • CORTEN STEEL



-  Galvanizado
Galvanized iron
-  Acero corten
Corten steel
-  Imitación corten
Corten steel imitation

JBUCAREST03

A	B	C
990	990	510
490	490	510
990	990	1000
990	490	510
990	490	1000

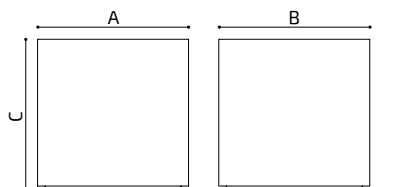

Medidas: mm.
Measures: mm.

 Opcional Hidrojardinería.
Optional Hidroplanter.

BRALLA

HIERRO GALVANIZADO • CORTEN | GALVANIZED IRON • CORTEN STEEL



-  Galvanizado
Galvanized iron
-  Acero corten
Corten steel
-  Imitación corten
Corten steel imitation

JBRALLA01

A	B	C	D
990	990	990	370
490	490	990	370
990	490	990	370

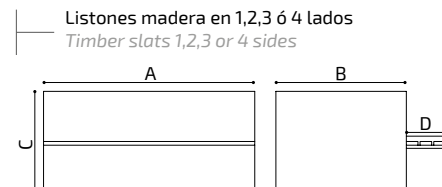

Medidas: mm.
Measures: mm.

Listones madera en 1,2,3 ó 4 lados
Timber slats 1,2,3 or 4 sides

 Opcional Hidrojardinería.
Optional Hidroplanter.

RECEI

HIERRO GALVANIZADO • CORTEN | GALVANIZED IRON • CORTEN STEEL



-  Galvanizado
Galvanized iron
-  Acero corten
Corten steel
-  Imitación corten
Corten steel imitation

JRECEI04C

A	B	C
990	990	460
490	490	460
990	990	950
990	490	460
990	490	950
750	750	700

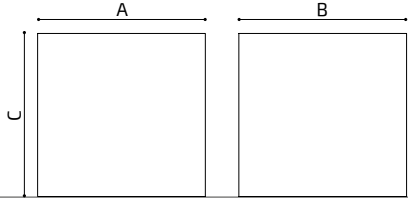

Medidas: mm.
Measures: mm.

 Opcional Hidrojardinera.
Optional Hidroplanter.

BAIA

HIERRO GALVANIZADO • CORTEN | GALVANIZED IRON • CORTEN STEEL



-  Galvanizado
Galvanized iron
-  Acero corten
Corten steel
-  Imitación corten
Corten steel imitation

JBAIAC01

A	B	C
1000	1000	920
500	500	420
1000	500	420
1000	500	920

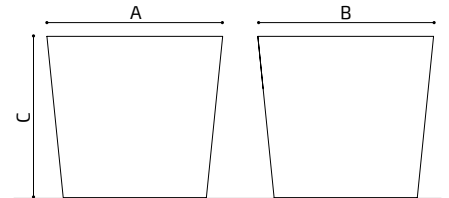

Medidas: mm.
Measures: mm.

 Opcional Hidrojardinera.
Optional Hidroplanter.

PREI

HIERRO GALVANIZADO • CORTEN | GALVANIZED IRON • CORTEN STEEL



-  Galvanizado
Galvanized iron
-  Acero corten
Corten steel
-  Imitación corten
Corten steel imitation

JPREI03

A	B	C
700	700	500
700	700	700

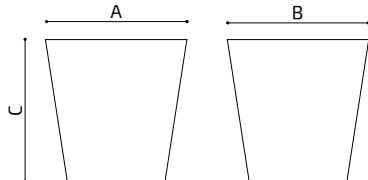

Medidas: mm.
Measures: mm.

 Opcional Hidrojardinera.
Optional Hidroplanter.

CLASIC

HIERRO GALVANIZADO • CORTEN | GALVANIZED IRON • CORTEN STEEL



-  Galvanizado
Galvanized iron
-  Acero corten
Corten steel
-  Imitación corten
Corten steel imitation

JCLASIC01

A	B	C
800	800	600
800	800	800

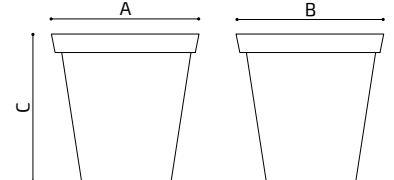

Medidas: mm.
Measures: mm.

 Opcional Hidrojardinera.
Optional Hidroplanter.

RESTA

HIERRO GALVANIZADO • CORTEN | GALVANIZED IRON • CORTEN STEEL



-  Galvanizado
Galvanized iron
-  Acero corten
Corten steel
-  Imitación corten
Corten steel imitation

JRESTA01C



Consultar modelo Eco
Consult model Eco

A	B	C
970	300	750
970	250	750

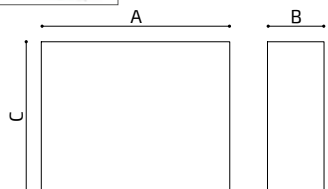

Medidas: mm.
Measures: mm.

 Opcional Hidrojardinera.
Optional Hidroplanter.

ARAN

HIERRO GALVANIZADO • CORTEN | GALVANIZED IRON • CORTEN STEEL



-  Galvanizado
Galvanized iron
-  Acero corten
Corten steel
-  Imitación corten
Corten steel imitation

JARAN01C



Consultar modelo Eco
Consult model Eco

A	B	C
970	300	850
970	250	850

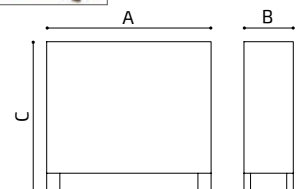

Medidas: mm.
Measures: mm.

 Opcional Hidrojardinera.
Optional Hidroplanter.

SHIP

HIERRO GALVANIZADO • CORTEN | GALVANIZED IRON • CORTEN STEEL



-  Galvanizado
Galvanized iron
-  Acero corten
Corten steel
-  Imitación corten
Corten steel imitation

JSHIPC01

A	B	C
1060	470	400

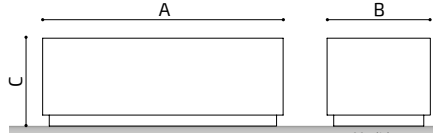

 Opcional Hidrojardinera.
Optional Hidroplanter.

Medidas: mm.
Measures: mm.

TEI

HIERRO GALVANIZADO • CORTEN | GALVANIZED IRON • CORTEN STEEL



-  Galvanizado
Galvanized iron
-  Acero corten
Corten steel
-  Imitación corten
Corten steel imitation

JHC02

A	B
∅ 950	700
∅ 950	500

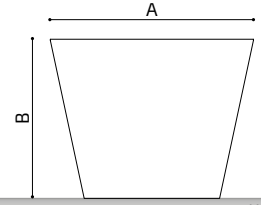

 Opcional Hidrojardinera.
Optional Hidroplanter.

Medidas: mm.
Measures: mm.

CURVI

HIERRO GALVANIZADO • CORTEN | GALVANIZED IRON • CORTEN STEEL



-  Galvanizado
Galvanized iron
-  Acero corten
Corten steel
-  Imitación corten
Corten steel imitation

JCURVI02L

A	B
∅ 950	900
∅ 950	490
∅ 630	900
∅ 630	490

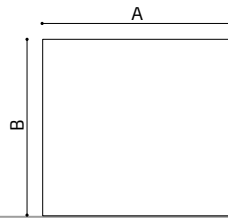

 Opcional Hidrojardinera.
Optional Hidroplanter.

Medidas: mm.
Measures: mm.

BRAND

HIERRO GALVANIZADO • CORTEN | GALVANIZED IRON • CORTEN STEEL



-  Galvanizado
Galvanized iron
-  Acero corten
Corten steel
-  Imitación corten
Corten steel imitation

JBRAND01

A	B
∅ 950	950
∅ 950	540
∅ 630	950
∅ 630	540

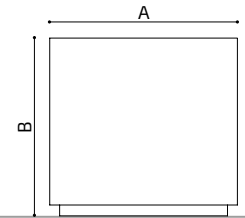

 Opcional Hidrojardinera.
Optional Hidroplanter.

Medidas: mm.
Measures: mm.

ALCOR

HIERRO • CORTEN • INOX. | IRON • CORTEN • STAINLESS STEEL



Jardinera - alcorque
construida a medida
Custom built planter
tree grate

ALCOR

 Opcional Hidrojardinera.
Optional Hidroplanter.

GREA

MADERA • HIERRO • CORTEN | WOOD • IRON • CORTEN



GREAO1

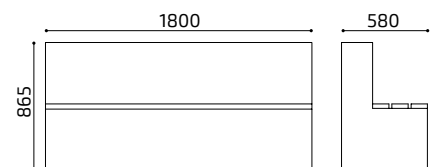

 Opcional Hidrojardinera.
Optional Hidroplanter.

Medidas: mm.
Measures: mm.

TRE

MADERA • HIERRO • CORTEN | WOOD • IRON • CORTEN



-  Galvanizado
Galvanized iron
-  Acero corten
Corten steel
-  Imitación corten
Corten steel imitation

JTREG01

A	B	C
738	738	570
1038	738	570
1038	1038	570

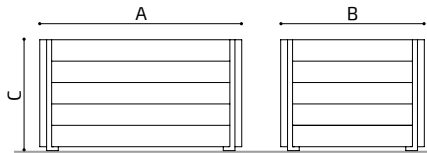

Medidas: mm.
Measures: mm.

 Opcional Hidrojardinera.
Optional Hidroplanter.

WOOD

MADERA • HIERRO • CORTEN • INOX. | WOOD • IRON • CORTEN • STAINLESS STEEL



-  Galvanizado
Galvanized iron
-  Acero corten
Corten steel
-  Imitación corten
Corten steel imitation

JWOODI01

A	B	C
738	738	570
1038	738	570
1038	1038	570

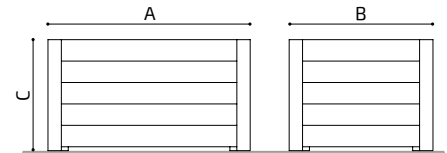

Medidas: mm.
Measures: mm.

 Opcional Hidrojardinera.
Optional Hidroplanter.

PINE

MADERA | WOOD



JPINE02

A	B	C
450	450	450
800	800	600

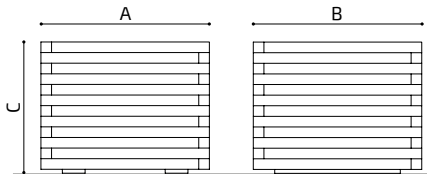

Medidas: mm.
Measures: mm.

 Opcional Hidrojardinera.
Optional Hidroplanter.

+ HIDROJARDINERAS HIDROPLANTERS



MADERA • HIERRO • CORTEN • INOX. / WOOD • IRON • CORTEN • STAINLESS STEEL

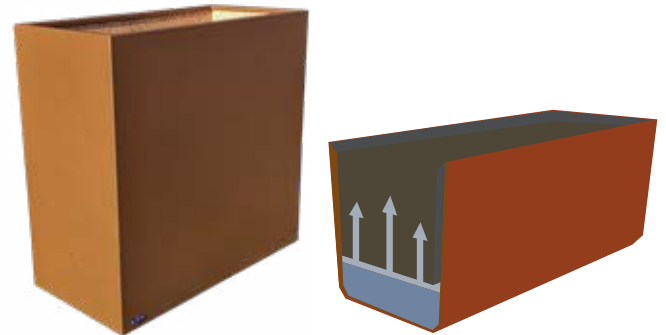

Si el cliente lo requiere, modificamos nuestras jardineras estándares a sistema de hidrojardineras incorporando un sistema de riego hidrológico con el objetivo de reducir el volumen de agua y reducir la frecuencia de riego.

If the client requires it, we modify our standard planters to a hydroplanter system incorporating a hydrological irrigation system in order to reduce the volume of water and reduce the frequency of irrigation.

+ JARDINERAS A MEDIDA / CUSTOMIZED FLOWER PLANTERS

MADERA • HIERRO • CORTEN • INOX. | WOOD • IRON • CORTEN • STAINLESS STEEL





JARDINERAS DE HORMIGÓN / FLOWER PLANTER CONCRETE



Hormi



Macar



Teo



Jardinera | Flower planter

SEGURIDAD ANTIALUNIZAJE / SECURITY

HIERRO • CORTEN • INOX. | IRON • CORTEN STEEL • STAINLESS STEEL

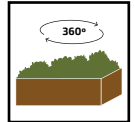

Jardineras de seguridad construidas especialmente para resistir los actos vandálicos de alunizaje de vehículos. Jardineras ideales para todos aquellos lugares donde existe riesgo de alunizaje y se necesite permitir el paso de vehículos ocasionalmente.

Reinforced security flower planters with high impact resistance. Anti-ram flower planter, ideal to be installed in risk places where there could be vehicular attacks and are needed to move sometimes.

Fabricación del modelo de jardinera que requiera el cliente, adaptando esta a los sistemas de seguridad necesarios.

Bespoke manufacturing, depending on the security level and the dimensions needed.



Jardineras en posición cerrada evitando el paso de vehículos.

Flower planter in closed position avoiding the circulation of vehicles.



Detalle de apertura del bloqueo de la jardinera.

Block system opening detail.



Inicio del sistema de giro de la jardinera.

Starting of the flower planter revolving system.



La jardinera gira 360° pudiendo elegir el recorrido en el momento de la instalación.

The flower planter can revolve 360°, being able to choose the path at the moment of the installation



Detalle bloqueo de la jardinera en el punto final.

Block system closing detail.



Jardineras en posición abierta para permitir el paso de vehículos.

Flower planter in opened position allowing the circulation of vehicles.

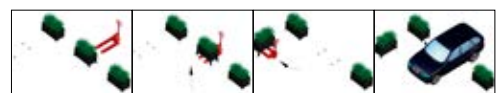



Escanear código QR ver en web / Scan the QR code to see on web



Ver todos los modelos en la web / See all models on the web



ALCORQUES PROTECTORES ÁRBOLES

TREE GRATES
TREE PROTECTORS



RELIGA CUADRADA

HIERRO GALVANIZADO | GALVANIZED IRON

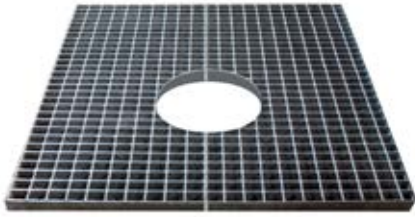

ALCURE900

A	B	C
900	900	50
1000	1000	50
1100	1100	50
1200	1200	50

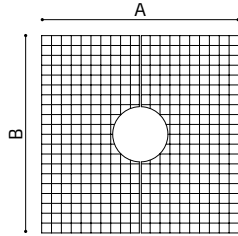

RELIGA CIRCULAR

HIERRO GALVANIZADO | GALVANIZED IRON

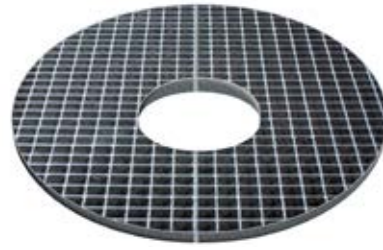

ALCIRED900

A	B
Ø 900	50
Ø 1000	50
Ø 1100	50
Ø 1200	50

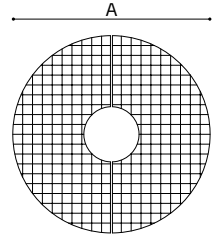

MARCO CUADRADO

HIERRO • CORTEN • INOX. | IRON • CORTEN STEEL • STAINLESS STEEL



ALCUMA1000G

A	B	C
1000	1000	200
1200	1200	200
1400	1400	200
1600	1600	200

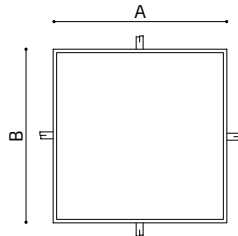

MARCO CIRCULAR

HIERRO • CORTEN • INOX. | IRON • CORTEN STEEL • STAINLESS STEEL



ALCIMAD900G

A	B
Ø 900	200
Ø 1600	200

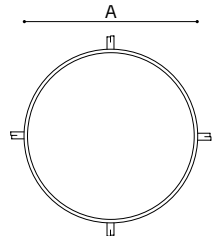

ONDA

HIERRO • CORTEN • INOX. | IRON • CORTEN STEEL • STAINLESS STEEL



ALON1000G

A	B	C
800	800	50
1000	1000	50
1200	1200	50
1500	1500	50

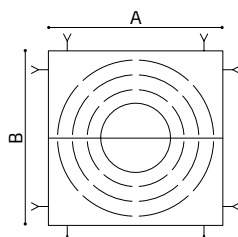

CONCENTRICO

HIERRO • CORTEN • INOX. | IRON • CORTEN STEEL • STAINLESS STEEL



ALCO1000G

A	B	C
800	800	50
1000	1000	50
1200	1200	50
1500	1500	50

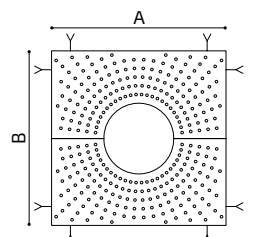

PUZZLE

HIERRO • CORTEN • INOX. | IRON • CORTEN STEEL • STAINLESS STEEL

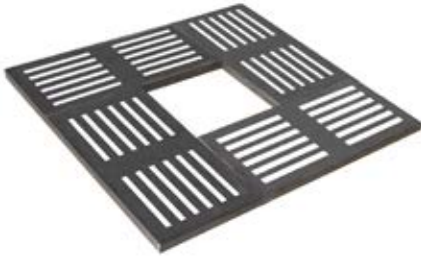

ALPU1000G

A	B	C
800	800	50
1000	1000	50
1200	1200	50
1500	1500	50

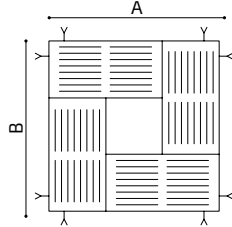

ROMBO

HIERRO • CORTEN • INOX. | IRON • CORTEN STEEL • STAINLESS STEEL



ALRO1000G

A	B	C
800	800	50
1000	1000	50
1200	1200	50
1500	1500	50

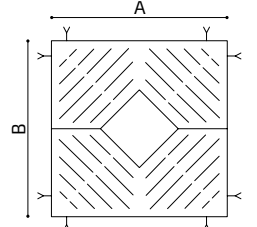

Protector árbol | Tree protector FICUS

H. GALVANIZADO • CORTEN • INOX. | GALVANIZED I. • CORTEN • STAINLESS STEEL



PTFIG

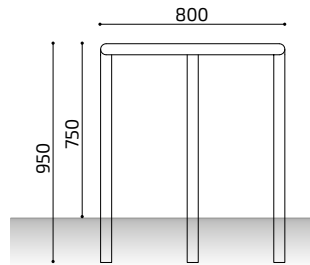

Protector árbol | Tree protector ROBLE

H. GALVANIZADO • CORTEN • INOX. | GALVANIZED I. • CORTEN • STAINLESS STEEL



PTROBLEGC

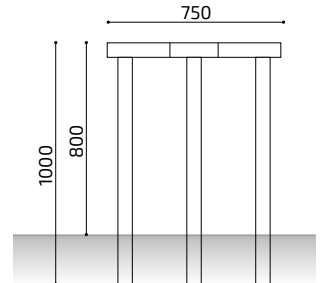

Protector árbol | Tree protector FRESNO

H. GALVANIZADO • CORTEN • INOX. | GALVANIZED I. • CORTEN • STAINLESS STEEL



PTFRESG

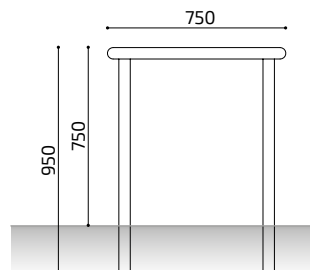

Protector árbol | Tree protector COPEY

H. GALVANIZADO • CORTEN • INOX. | GALVANIZED I. • CORTEN • STAINLESS STEEL



PTCOPEY

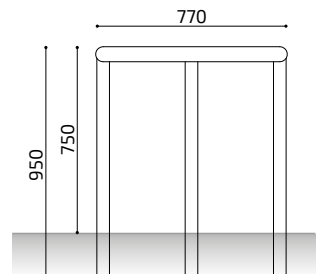



Escanear código QR ver en web / Scan the QR code to see on web



Ver todos los modelos en la web / See all models on the web



BARANDILLAS

RAILINGS

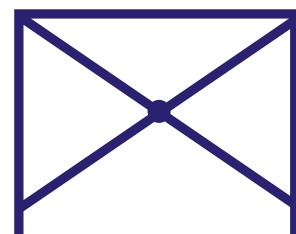

UNIVERSO

H. GALVANIZADO • CORTEN • INOX. | GALVANIZED I. • CORTEN • STAINLESS STEEL



Opcional: Galvanizado en caliente
Optional: Hot galvanized

BUNIVG2.0

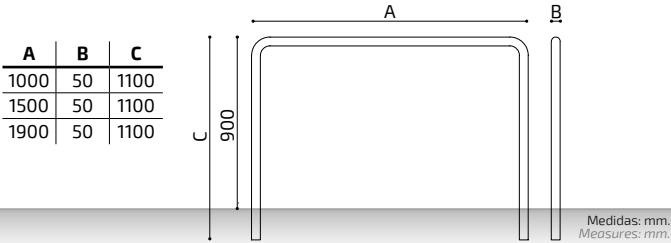

UNIVERSO MAX

H. GALVANIZADO • CORTEN • INOX. | GALVANIZED I. • CORTEN • STAINLESS STEEL



Opcional: Galvanizado en caliente
Optional: Hot galvanized

BUNIVMG2.0

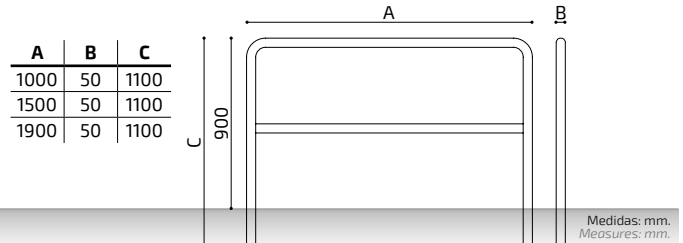

UNIVERSO PLUS

H. GALVANIZADO • CORTEN • INOX. | GALVANIZED I. • CORTEN • STAINLESS STEEL



Opcional: Galvanizado en caliente
Optional: Hot galvanized

BUNIVPG2.0

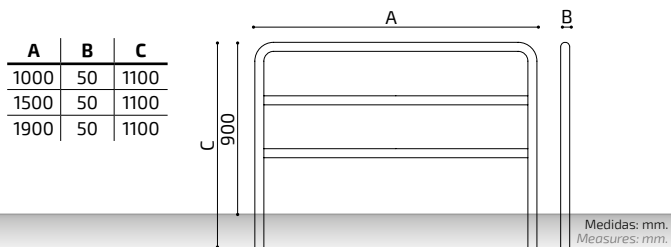

BARCINO

H. GALVANIZADO • CORTEN • INOX. | GALVANIZED I. • CORTEN • STAINLESS STEEL



Barandilla homologada
Homologated railing



BBARCINO1.5

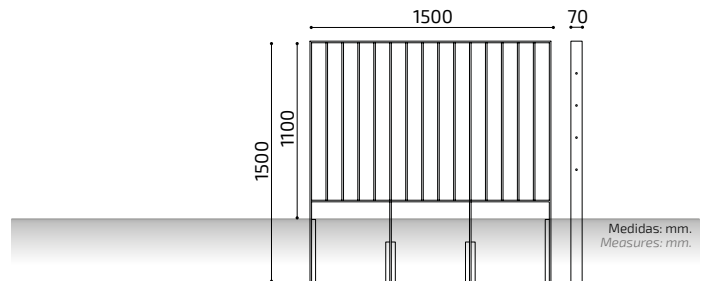

APOLO

H. GALVANIZADO • CORTEN • INOX. | GALVANIZED I. • CORTEN • STAINLESS STEEL



Cantos redondeados
Rounded corners

BAPOLOG1.5P

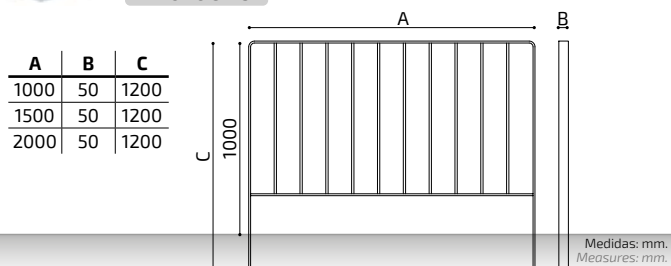

FEBO

H. GALVANIZADO • CORTEN • INOX. | GALVANIZED I. • CORTEN • STAINLESS STEEL



Cantos redondeados
Rounded corners

BFEBOG1.5P

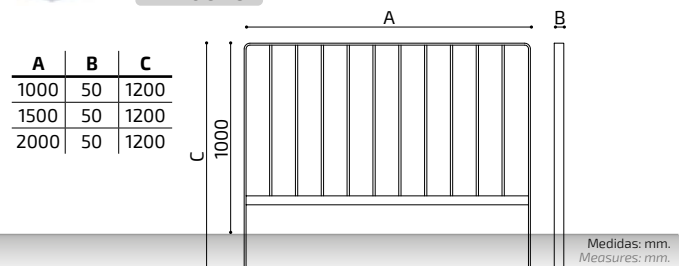

QUEEN

H. GALVANIZADO • CORTEN • INOX. | GALVANIZED I. • CORTEN • STAINLESS STEEL

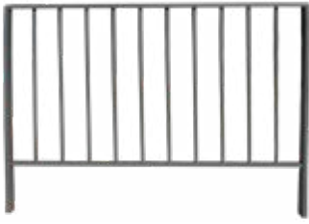

BQUEENON1.5

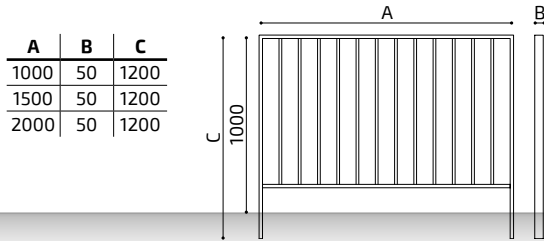

Medidas: mm.
Measures: mm.

KING

H. GALVANIZADO • CORTEN • INOX. | GALVANIZED I. • CORTEN • STAINLESS STEEL

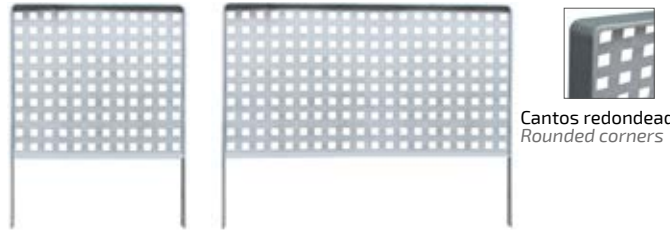

Cantos redondeados
Rounded corners

BKING1.0

BKING2.0

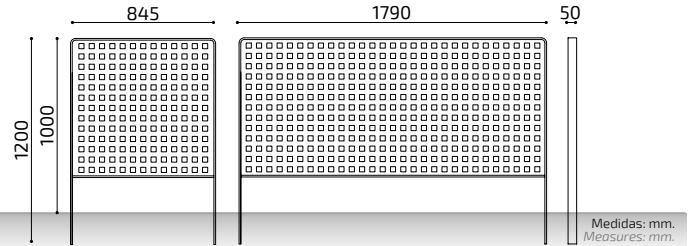

Medidas: mm.
Measures: mm.

EIXAMPLE

HIERRO | IRON

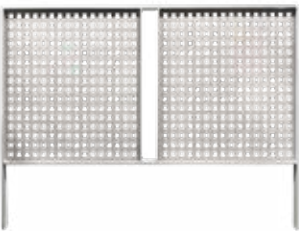

BEIXG70042.0

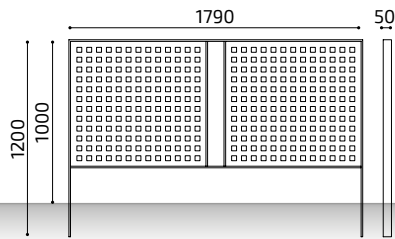

Medidas: mm.
Measures: mm.

EROS

H. GALVANIZADO • CORTEN • INOX. | GALVANIZED I. • CORTEN • STAINLESS STEEL

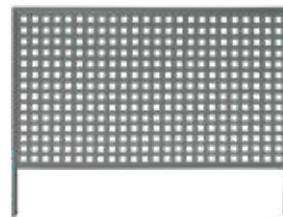

BEROSON1.5

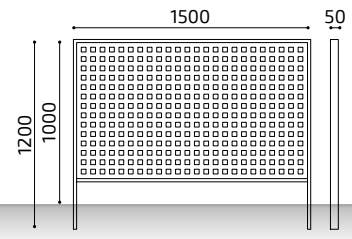

Medidas: mm.
Measures: mm.

ASPA

H. GALVANIZADO • CORTEN • INOX. | GALVANIZED I. • CORTEN • STAINLESS STEEL

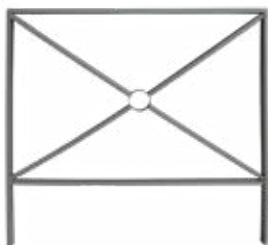

Opcional
Optional

BASPAON1.2

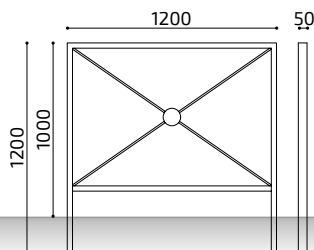

Medidas: mm.
Measures: mm.

ASPEN

H. GALVANIZADO • CORTEN • INOX. | GALVANIZED I. • CORTEN • STAINLESS STEEL

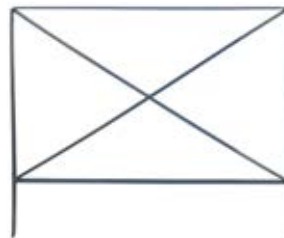

Cantos redondeados
Rounded corners



BASPENON1.2

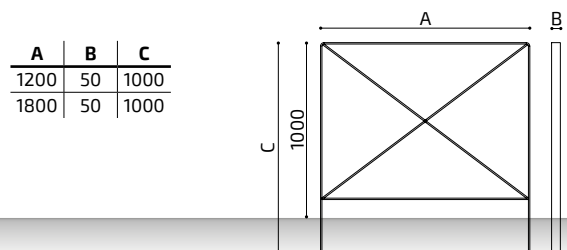

Medidas: mm.
Measures: mm.

HERA

HIERRO GALVANIZADO | GALVANIZED IRON



BHERAG2.0P

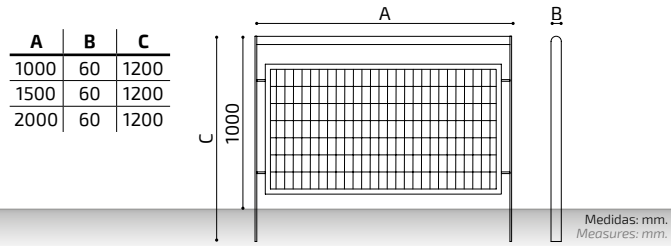

GALI

HIERRO GALVANIZADO • ACERO INOX. | GALVANIZED IRON • STAINLESS STEEL



BGALIG2.0

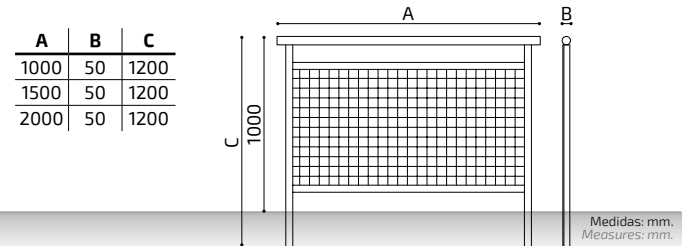

DOLAI

H. GALVANIZADO • CORTEN • INOX. | GALVANIZED I. • CORTEN • STAINLESS STEEL

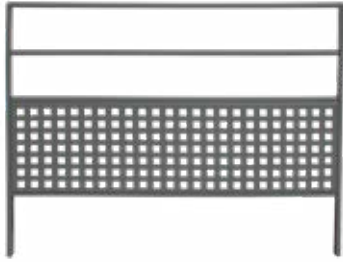

BDOLAION1.5

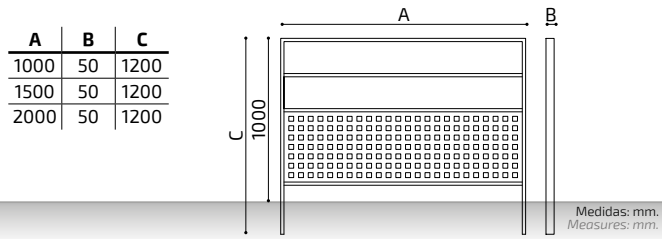

ZEUS

HIERRO • CORTEN • INOX. | IRON • CORTEN • STAINLESS STEEL



BZEUS1.5

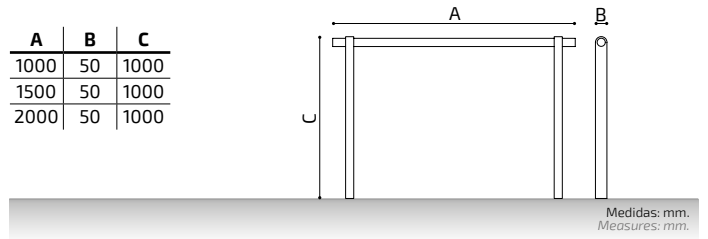

TSC

HIERRO GALVANIZADO • CORTEN | GALVANIZED IRON • CORTEN STEEL



BTSC1.5P

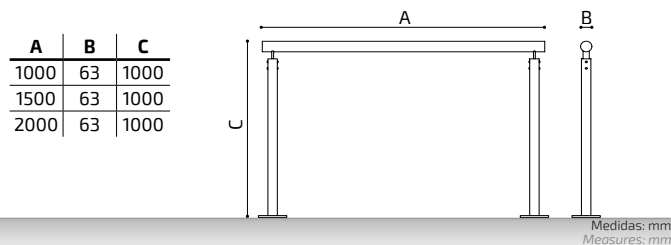

OLIMPO

HIERRO • CORTEN • INOX. | IRON • CORTEN • STAINLESS STEEL



BOLIMPO1.5

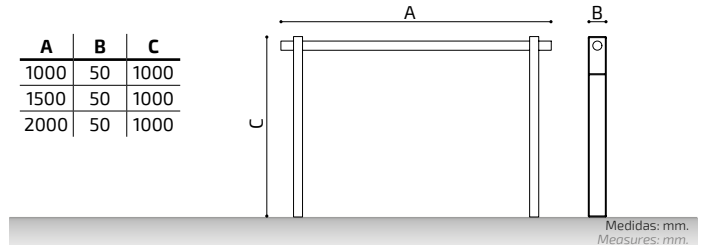



DISEÑOS A MEDIDA / CUSTOMIZED DESIGNS

HIERRO • CORTEN • ACERO INOXIDABLE | IRON • CORTEN • STAINLESS STEEL

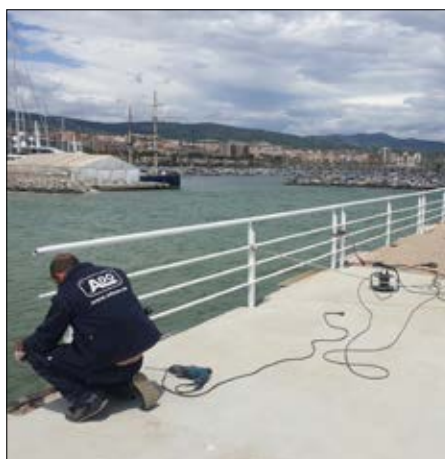

PARC

HIERRO GALVANIZADO • CORTEN | GALVANIZED IRON • CORTEN STEEL



BPARCG

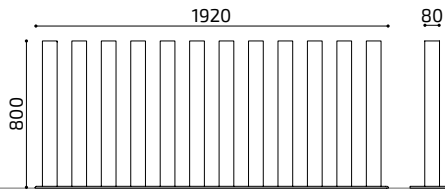

Medidas: mm.
Measures: mm.

PARC BCN

HIERRO GALVANIZADO • CORTEN | GALVANIZED IRON • CORTEN STEEL



BPARCBCNG

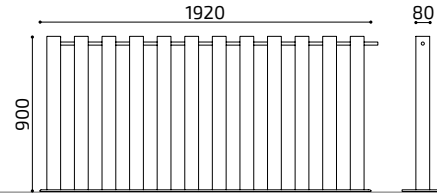

Medidas: mm.
Measures: mm.

PLAY

HIERRO GALVANIZADO | GALVANIZED IRON



VCOL



VCOLP01

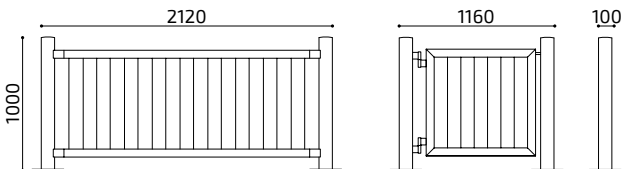

Medidas: mm.
Measures: mm.

FUSTAL

MADERA | WOOD



78020

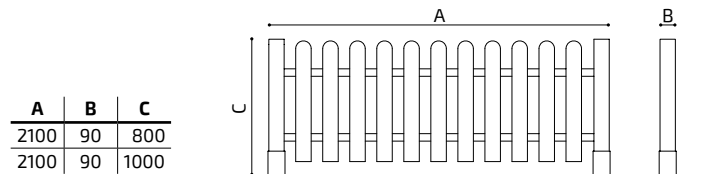

Medidas: mm.
Measures: mm.

YELLOWSTONE

MADERA + HIERRO GALVANIZADO | WOOD + GALVANIZED IRON



VYELLOWSTONE1.2V

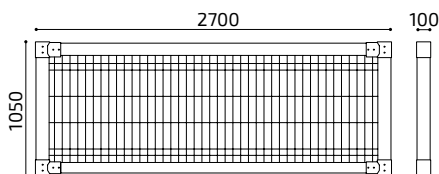

Medidas: mm.
Measures: mm.





Escanear código QR ver en web / Scan the QR code to see on web



Ver todos los modelos en la web / See all models on the web



VALLAS / CONOS POSTES CINTA EXTENSIBLE

FENCES / CONES EXTENSIBLE TAPE POST

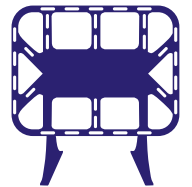

LOCKER



PLÁSTICO POLIPROPILENO | POLYPROPYLENE PLASTIC

MODELO PATENTADO
PATENTED MODEL



VL01AM



VL01RO



VL01AZ

- Diseño / Design
- Ecológica / Ecological
- Resistente / Resistant

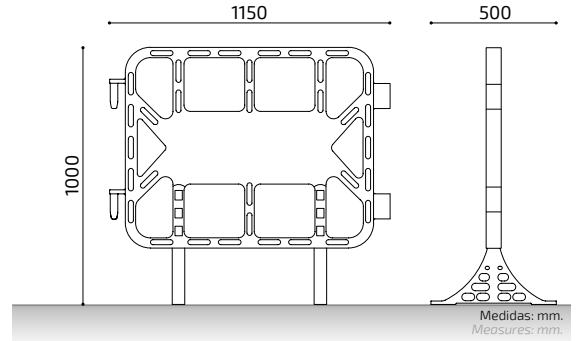

STOPPER



PLÁSTICO POLIPROPILENO | POLYPROPYLENE PLASTIC

MODELO PATENTADO
PATENTED MODEL

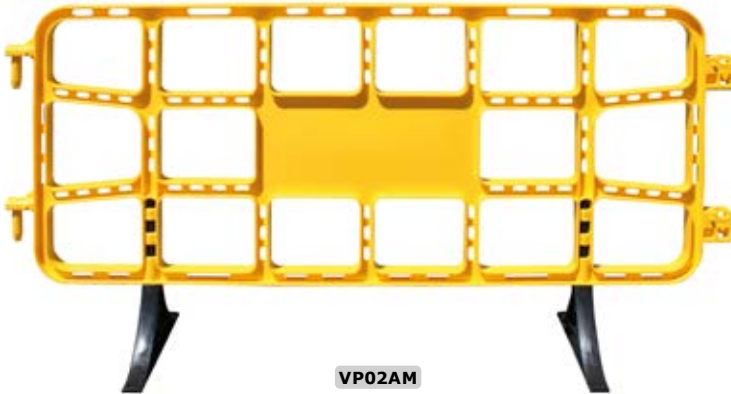

VP02AM



VP02RO



VP02AZ

- Diseño / Design
- Ecológica / Ecological
- Resistente / Resistant

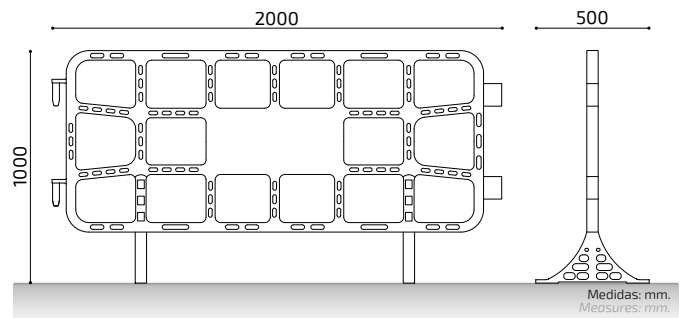

PERSONALIZACIÓN / CUSTOMIZATION

- Personalización del escudo, logo o texto identificativo en el panel central (gran formato para publicidad 600x280 mm).
Customizable: we can print your shield, logo or text in the centre panel (big advertising panel 600x280 mm).

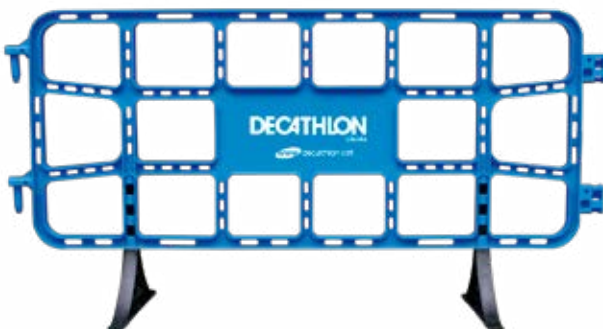

PLEXTEN

PLÁSTICO | PLASTIC



VEXP01

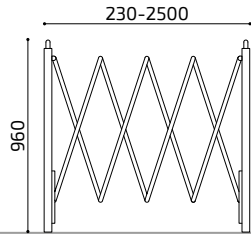

Medidas: mm.
Measures: mm.

CADENAS PLÁSTICO / PLASTIC CHAINS

PLÁSTICO | PLASTIC



CP825RB



CP825AN



25M Longitud.
Length.

POSTES CINTA EXTENSIBLE RETRACTABLE BELT BARRIER

HIERRO • ACERO INOXIDABLE | IRON • STAINLESS STEEL



PCEAICA2

PCEHNCA2

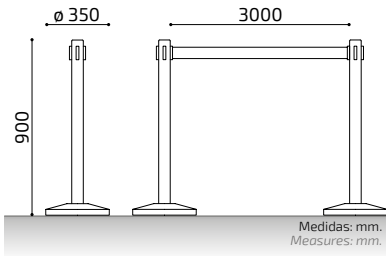

Medidas: mm.
Measures: mm.

3M Longitud cinta.
Tape length.

SEPARADOR DE CINTA PARED WALL RETRACTABLE BELT BARRIER

ACERO INOXIDABLE | STAINLESS STEEL



SCEPI

SCEPIR

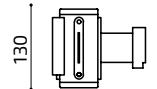
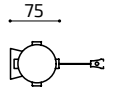

2,3M Longitud cinta.
Tape length.

Separador cinta extensible | Extensible tape separator

SPACE

PLÁSTICO | PLASTIC



SCEMN

ø 146

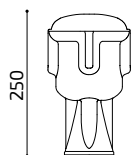

250



9M Longitud cinta.
Tape length.



ACCESORIOS ACCESSORIES



ANETO

PLÁSTICO PVC | PLASTIC PVC



Personalización logo o texto identificativo sobre la superficie del cono o sobre la reflectancia
 Custom traffic cones with logo or text printed on the surface or on the reflective tape

CP02

CP01A

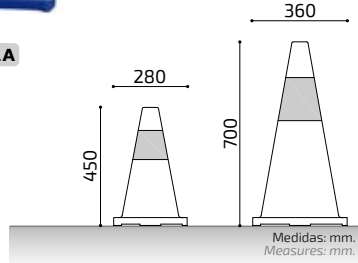

EVEREST

PLÁSTICO PE + CAUCHO | PLASTIC PE + RUBBER



Personalización logo o texto identificativo sobre la superficie del cono o sobre la reflectancia
 Custom traffic cones with logo or text printed on the surface or on the reflective tape

CPBC02

CPBC01A

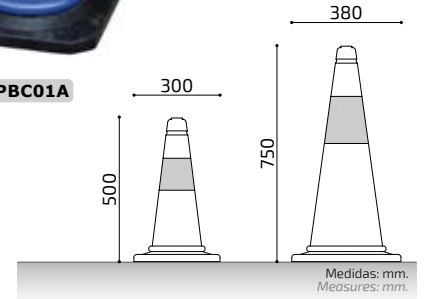

TEIDE

PLÁSTICO PE + TELA REFLECTANTE | PLASTIC PE + REFLECTIVE CLOTH



Luz interior:
Fija / intermitente
Internal illumination:
Fixed / flashing light



CPLEGABLE01

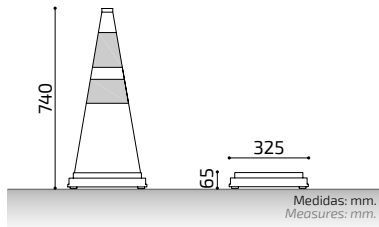

MONCAYO

PLÁSTICO PE + CAUCHO + TELA REFLECTANTE | PLASTIC PE + RUBBER + REFLECTIVE CLOTH



Luz interior:
Fija / intermitente
Internal illumination:
Fixed / flashing light



CPLEGABLE01

CPLEGABLE02

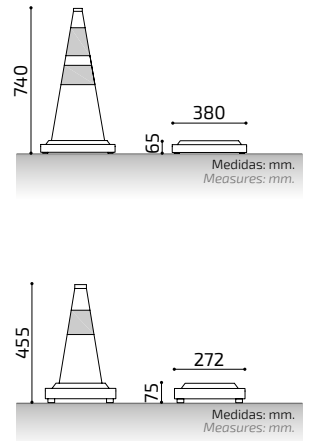

Tetrápodo policial | Police tetrapod

ALPES

PLÁSTICO | PLASTIC



CTETRA01

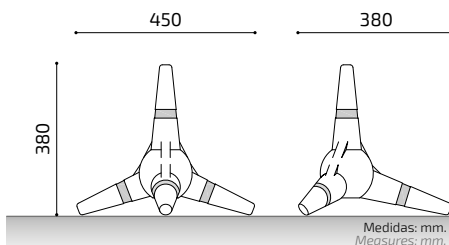

Enganche conos | Cones bar

CONEX

PLÁSTICO | PLASTIC



Detalle
Detail



PEXRB

PEXAN

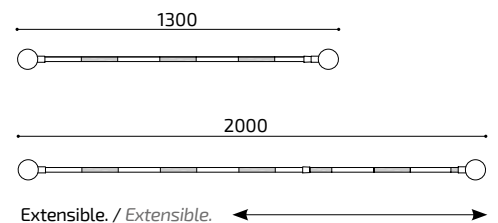





Escanear código QR ver en web / Scan the QR code to see on web



Ver todos los modelos en la web / See all models on the web



SEPARADORES VIALES BANDAS REDUCTORAS

ROAD SEPARATORS SPEED HUMPS



Separador Vial Modular | *Modular Road Separator*

MOMPE 

CAUCHO | RUBBER

MODELO PATENTADO
PATENTED MODEL



Homologado
Homologated



MOMPEI

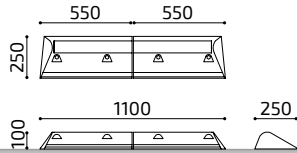

Medidas: mm.
Measures: mm.

Separador Vial Modular | *Modular Road Separator*

MOMPE 2 

CAUCHO | RUBBER

MODELO PATENTADO
PATENTED MODEL



MOMPEI2

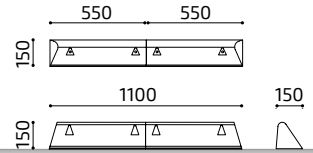

Medidas: mm.
Measures: mm.

MOMPE 3 

CAUCHO | RUBBER

MODELO PATENTADO
PATENTED MODEL



MOMPE3

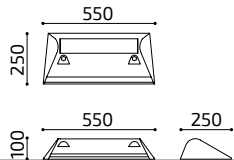

Medidas: mm.
Measures: mm.



TIGRE 

CAUCHO | RUBBER



TIGREVB01

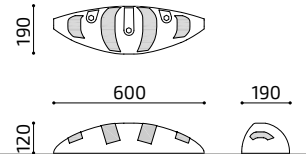

Medidas: mm.
Measures: mm.



PANTERA 

PLÁSTICO | PLASTIC

MODELO PATENTADO
PATENTED MODEL



PANTERARB01

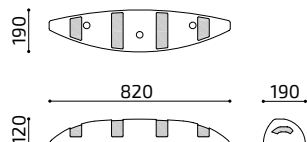

Medidas: mm.
Measures: mm.



PITÓN 

PLÁSTICO | PLASTIC

MODELO PATENTADO
PATENTED MODEL



PITONRB01

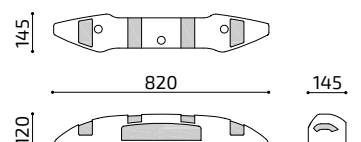

Medidas: mm.
Measures: mm.



Separador Vial | Road Separator **BUTTON**

CAUCHO | RUBBER



Separador Vial Asimétrico | Modular Road Asymmetric **SEMARY**

CAUCHO | RUBBER

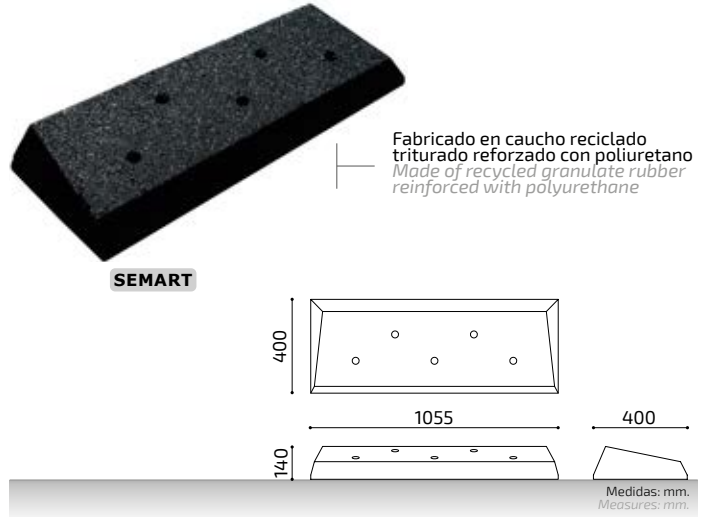

Separador Vial | Road Separator **SEVI**

CAUCHO | RUBBER

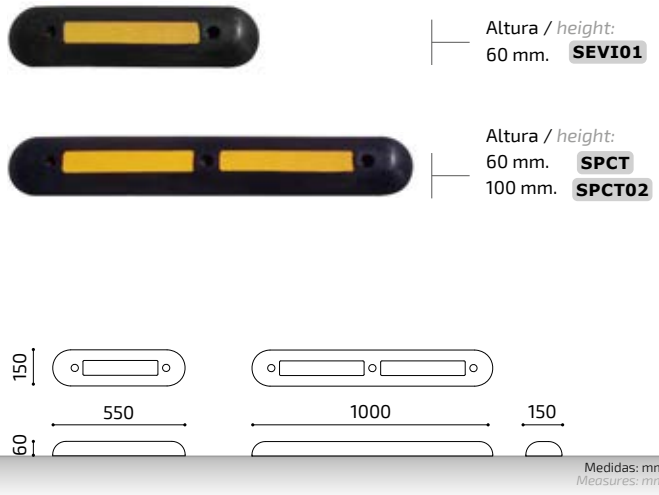

Separador Vial Modular | Modular Road Separator **SEVIMO**

CAUCHO | RUBBER



Cojín berlínés | Speed humps

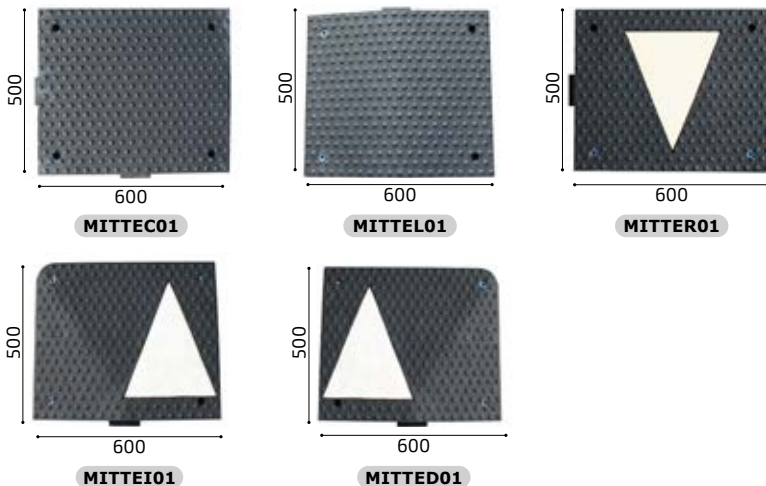

COJÍN BERLINÉS DE CAUCHO. ALTURA 70 MM. | RUBBER SPEED CUSHION. HEIGHT 70 MM.



Bandas Reductoras Velocidad | Speed Humps

CAUCHO | RUBBER

ALTURA 30 MM | HEIGHT 30 MM

 Pegatina microesfera Microsphere sticker	 Pegatina reflectante Reflective sticker	 Caucho Rubber
--	---	---

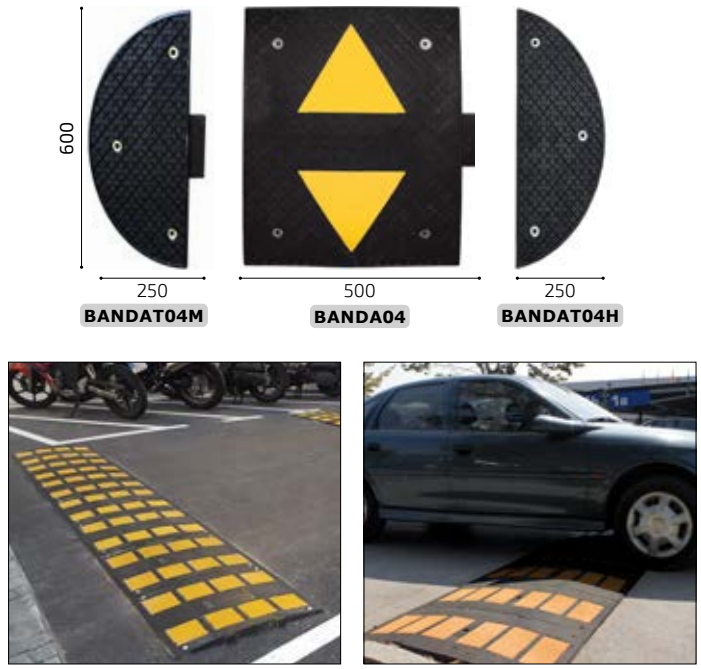
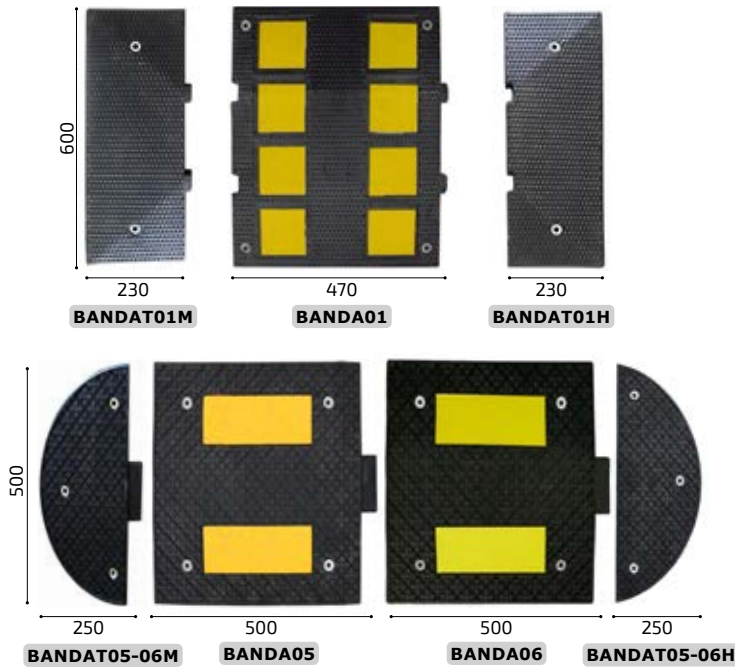

ALTURA 50 MM | HEIGHT 50 MM

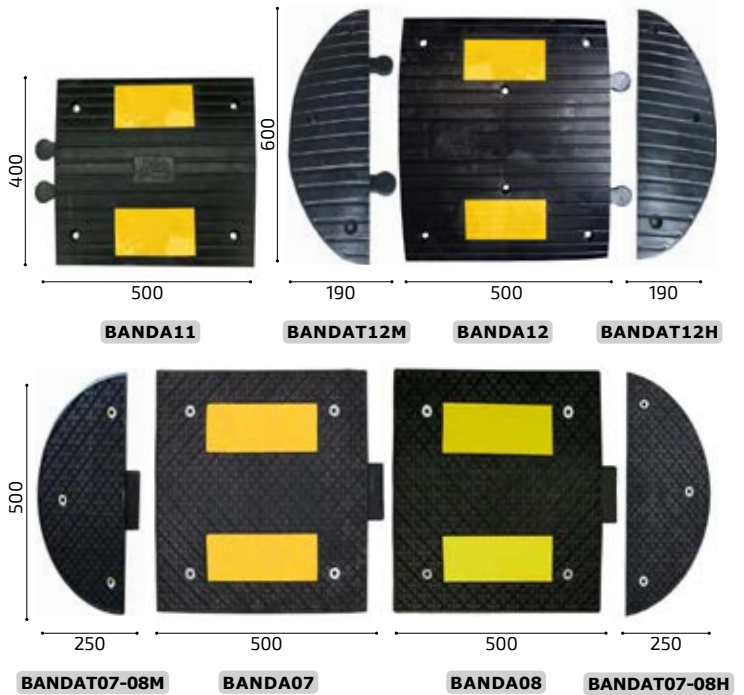
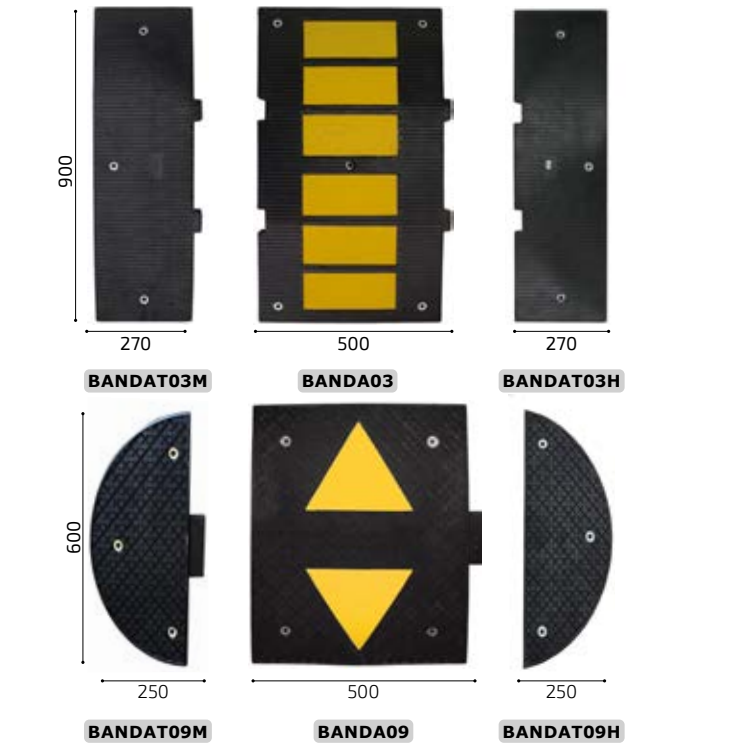

ALTURA 70 MM | HEIGHT 70 MM

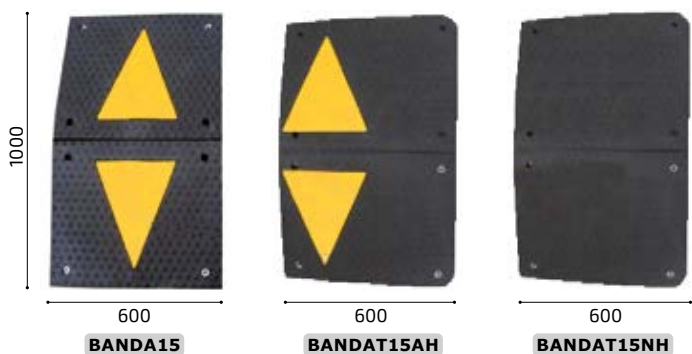

Bandas Reductoras Portátil | Portable Speed Humps

PORTBAND

PLÁSTICO | PLASTIC

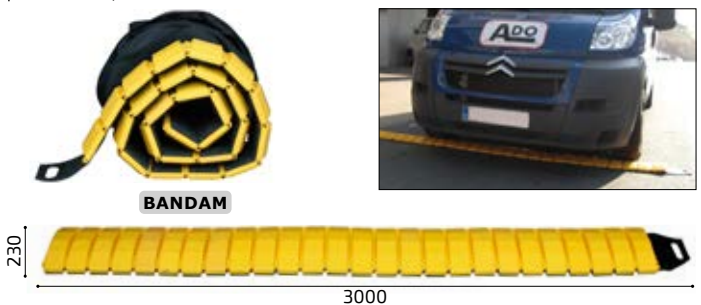



Escanear código QR ver en web / Scan the QR code to see on web



Ver todos los modelos en la web / See all models on the web



TOPES DE RUEDAS TOPES DE VEHÍCULOS

WHEEL STOPPERS
VEHICLE STOPPERS

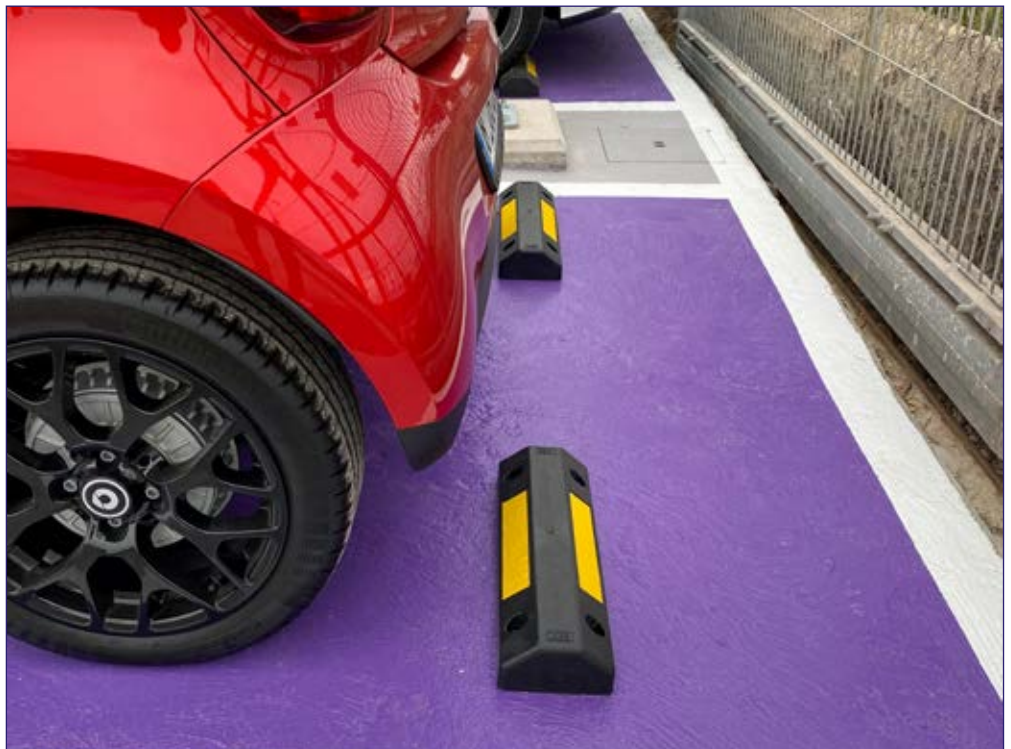

SILVER
PLÁSTICO | PLASTIC



TPSILVER01

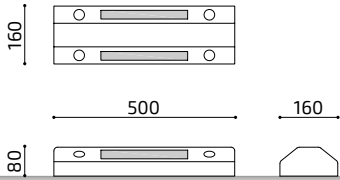

Medidas: mm.
Measures: mm.

INTERLAGOS
CAUCHO | RUBBER



TP03

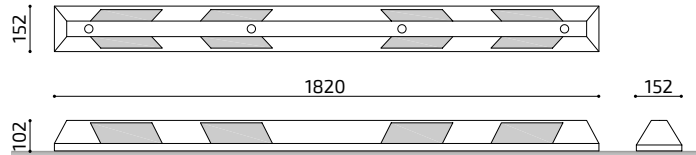

Medidas: mm.
Measures: mm.

CHESTE
HIERRO | IRON



TPCHESTE01AM



TPCHESTE02AM

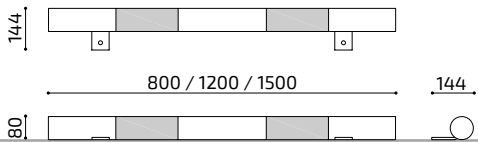

Medidas: mm.
Measures: mm.

DAKAR
HIERRO | IRON



TPH01



TPH02

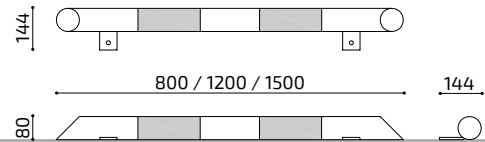

Medidas: mm.
Measures: mm.

FENIX
HIERRO | IRON



TPFENIX01RB



TPFENIX01NA

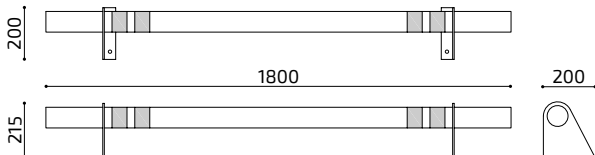

Medidas: mm.
Measures: mm.

JEREZ
HIERRO | IRON



TPJEREZRB01



TPJEREZAM01

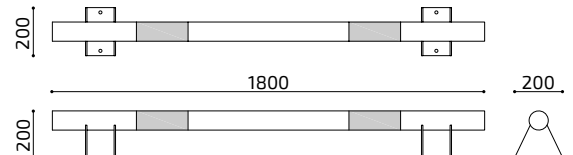

Medidas: mm.
Measures: mm.

CALIFORNIA

HORMIGÓN | CONCRETE



TPHCALIFORNIA

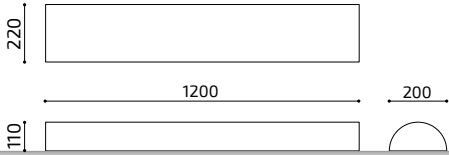

Medidas: mm.
Measures: mm.

DAYTONA

HORMIGÓN | CONCRETE



TPHO01

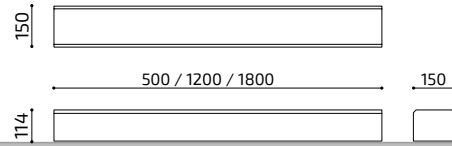

Medidas: mm.
Measures: mm.

TITAN

HIERRO GALVANIZADO • HIERRO • ACERO INOX. | GALVANIZED IRON • IRON • STAINLESS STEEL



TITAN01

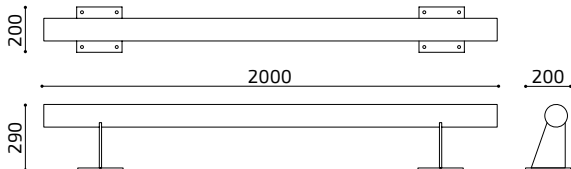

Medidas: mm.
Measures: mm.



PROTECTORES METÁLICOS / METALLIC PROTECTORS

HIERRO | IRON





Escanear código QR ver en web / Scan the QR code to see on web



Ver todos los modelos en la web / See all models on the web



SEÑALES TRÁFICO BALIZAS LUMINOSAS

TRAFFIC SIGNS
ROAD STUDS

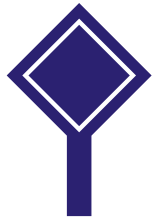

SEÑALES TRÁFICO

TRAFFIC SIGNS

HIERRO • ALUMINIO | IRON • ALUMINIUM



- Señales de tráfico de acero según normativa MOPU.
- Varios niveles de reflectancia.
- Traffic signs MOPU steel according to regulations.
- Various levels of reflectance.



SEÑALES INFORMATIVAS

INFORMATION SIGNS

HIERRO • ALUMINIO • PLÁSTICO | IRON • ALUMINIUM • PLASTIC



TOTEMS INFORMATIVOS

NEWS TOTEMS

HIERRO • ALUMINIO • CORTEN • INOX | IRON • ALUMINIUM • CORTEN • STAINLESS STEEL



SEÑALES ZONAS VERDES

GREEN ZONE SIGNS

HIERRO • CORTEN • ALUMINIO | IRON • CORTEN • ALUMINIUM



CUPO

HIERRO GALVANIZADO • INOX. | GALVANIZED IRON • STAINLESS STEEL

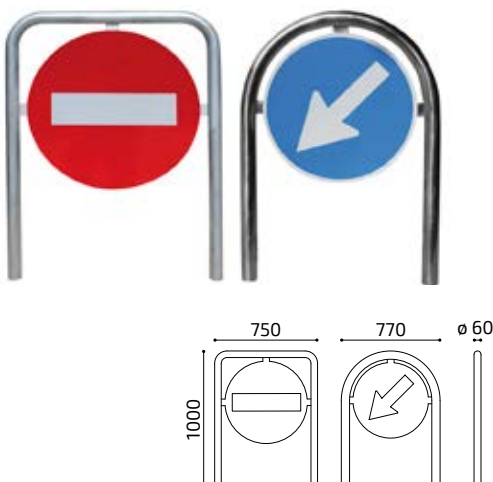

Medidas: mm.
Measures: mm.

SEÑALES EXCEPCIONALES

EXCEPTIONAL SIGNS

PLASTIC PVC • POLICARBONATO | PLASTIC PVC • POLYCARBONATE



PLACAS CALLE PLATES STREET SIGNS

ALUMINIO • HIERRO • PLÁSTICO | ALUMINIUM • IRON • PLASTIC



- Placas de calle personalizadas, diseños y medidas según necesidad cliente.
Plates street signs custom designs and sizes according to customer needs.

SEÑALES TRÁFICO LUMINOSAS LIGHT TRAFFIC SIGNS

HIERRO GALVANIZADO | GALVANIZED IRON



SETRALEDS01

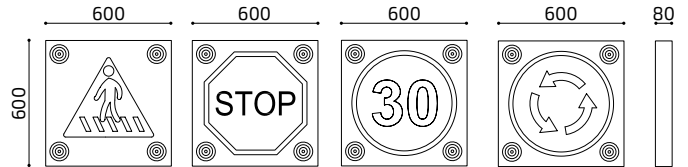

Señal advertencia suelo | Warning floor sign SLIPPER

PLÁSTICO | PLASTIC



SEASR01

SEASR02

Posibilidad de adhesivo personalizado.
Possibility of personalised stickers.

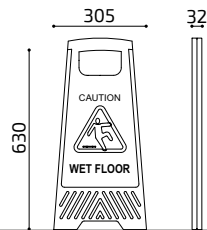

Medidas: mm.
Measures: mm.

Señal tráfico c. trípode | Traffic sign w. tripod TRIPOD

PLÁSTICO • ALUMINIO | PLASTIC • ALUMINIUM



Señal / Signal
Trípode / Tripod

SEPLE
TRITE01

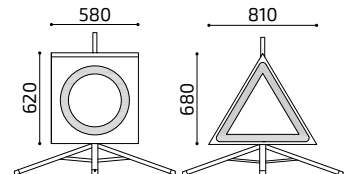

Medidas: mm.
Measures: mm.

Plantillas Marcaje Suelo | Marking Floor Templates PLANFOR

HIERRO GALVANIZADO | GALVANIZED IRON



Protector señales tráfico | Traffic signals protector PROSE

HIERRO GALVANIZADO | GALVANIZED IRON



PROSEUPNG

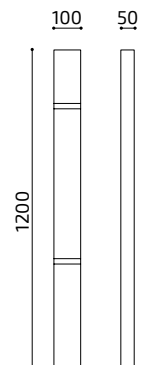

Medidas: mm.
Measures: mm.

Semáforo de leds | Led Traffic Light MONACO / MISANO / MONZA

PLÁSTICO | PLASTIC



SFLE3



SFLE3RV



SFLE7RAV

Semáforo portátil | Portable Traffic Light PERSEO

PLÁSTICO • HIERRO | PLASTIC • IRON



SPERSEOB

Altura ajustable
Adjustable height

Fácil montaje / desmontaje
Easy assembly / disassembly



Funciona a batería
Battery-operated

BALIZAS LUMINOSAS SOLARES

Solar Road Studs



EMPO



QUICK



WATERSKY



MOONDOG



VULCANO



FIRE



FLAME

Varios modelos a elegir según necesidades obra, posibilidad de elección de número de leds (fijos o intermitentes), colores de led. Consultar resistencias de tonelaje de cada modelo.

Different models available to meet clients' requirements. Possibility to choose the number and colours of LED lights, being it fixed or flashing lighting. Check tonnage resistance of each model.



Consulte el modelo que más se adapte a su instalación.
Consult the model that best suits your installation needs.

BALIZAS LUMINOSAS CABLEADAS

Wired Road Studs



SUNSHINE



GLORY



SUNBOW



LAKE



BLACKSUN



FROST



BOREAL



RAINBOW



WATERSKY

Programador Balizas Luminosas
Road Studs Controller



Varios modelos a elegir según necesidades obra, posibilidad de elección de número de leds (fijos o intermitentes), colores de led. Consultar resistencias de tonelaje de cada modelo.

Different models available to meet clients' requirements. Possibility to choose the number and colours of LED lights, being it fixed or flashing lighting. Check tonnage resistance of each model.



Consulte el modelo que más se adapte a su instalación.
Consult the model that best suits your installation needs.

Captafaro reflectante | *Traffic Reflector*
REFLEX

ALUMINIO | ALUMINIUM



BNB01EM2C

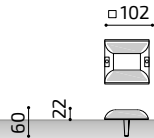

Medidas: mm.
Measures: mm.

Captafaro reflectante | *Traffic Reflector*
SHINE

PLÁSTICO | PLASTIC

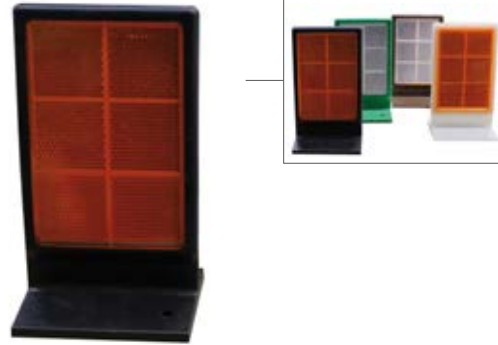

SHINENNA

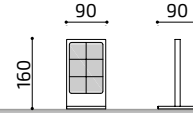

Medidas: mm.
Measures: mm.

Baliza señalizadora seguridad | *Safety Control Light*
STAR

POLICARBONATO | POLYCARBONATE



KBL4CCA01

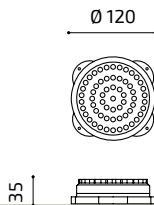

Medidas: mm.
Measures: mm.

Lámpara de destellos | *Warning lamps*
FIASO

PLÁSTICO | PLASTIC



LFIASO

Luz: Fija / intermitente
Internal: Fixed / flashing light

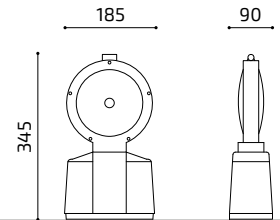

Medidas: mm.
Measures: mm.

Baliza señalizadora seguridad | *Safety Control Light*
EMPA

POLICARBONATO | POLYCARBONATE

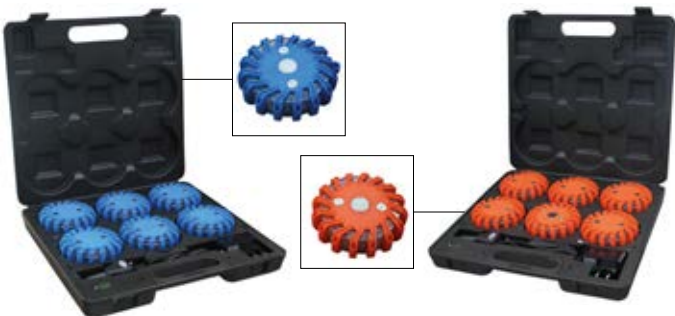

EMPAAZ01

EMPANA01

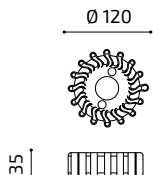

Medidas: mm.
Measures: mm.

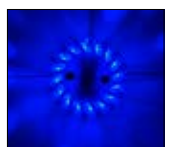
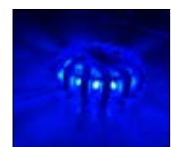

9 programas diferentes de iluminación. / 9 different lighting programs.



Escanear código QR ver en web / Scan the QR code to see on web



Ver todos los modelos en la web / See all models on the web



OTROS PRODUCTOS

OTHER PRODUCTS



ESPEJOS CONVEXOS CONVEX MIRRORS

PLÁSTICO | PLASTIC



Espejo exterior

Outdoor mirror

Ref.	Ø
ESPE60	600
ESPE80	800

ESPE60

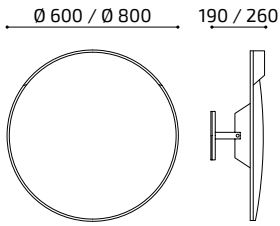

Espejo interior

Indoor mirror

Ref.	Ø
ESPI45	500
ESPI60	600

ESPI60

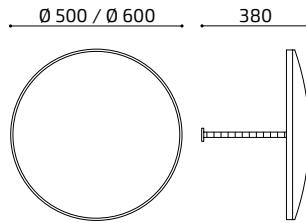

ISLETA HORMIGÓN CONCRETE TRAFFIC ISLAND

HORMIGÓN | CONCRETE



ISLETAHOR01

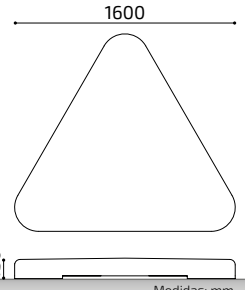

Medidas: mm.
Measures: mm.

CEPO INMOVILIZADOR / WHEEL IMMOBILIZER

HIERRO | IRON



CEPOP01



CEPOM01



CEPOG01

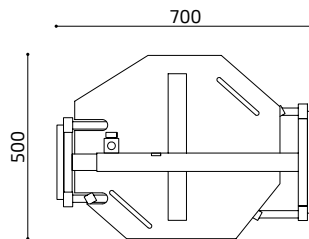
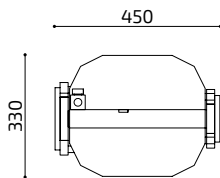
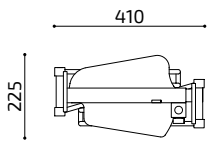

Salva zanjas | Trench cover SWIPER

FIBRA DE VIDRIO | GLASS REINFORCED COMPOSITE



SWIPER01

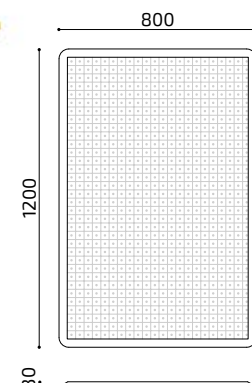

Medidas: mm.
Measures: mm.

Salva zanjas | Trench cover LIPER

FIBRA DE VIDRIO | GLASS REINFORCED COMPOSITE



LIPER01

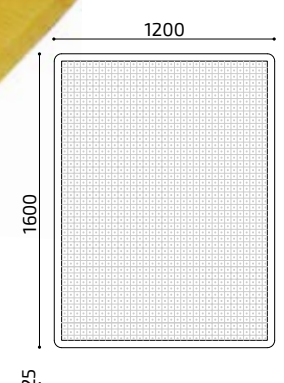

Medidas: mm.
Measures: mm.

Salva zanjas | Trench cover

PLASTRONG

PLÁSTICO + HIERRO | PLASTIC + IRON

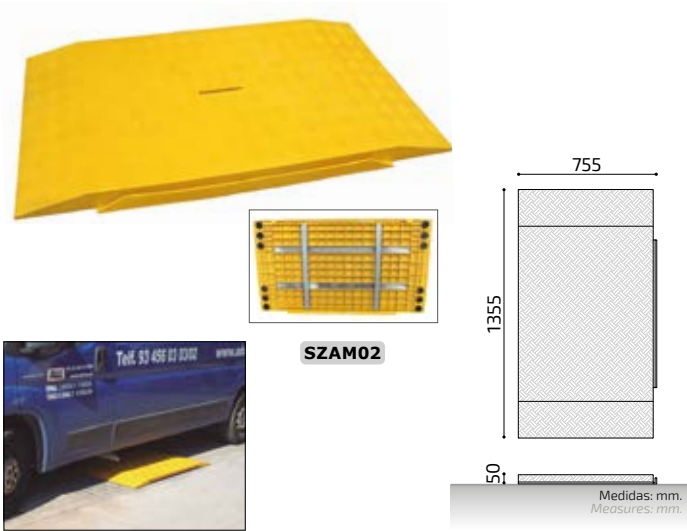

Salva rampas | Safekerb Ramp

FLAIER

PLÁSTICO | PLASTIC

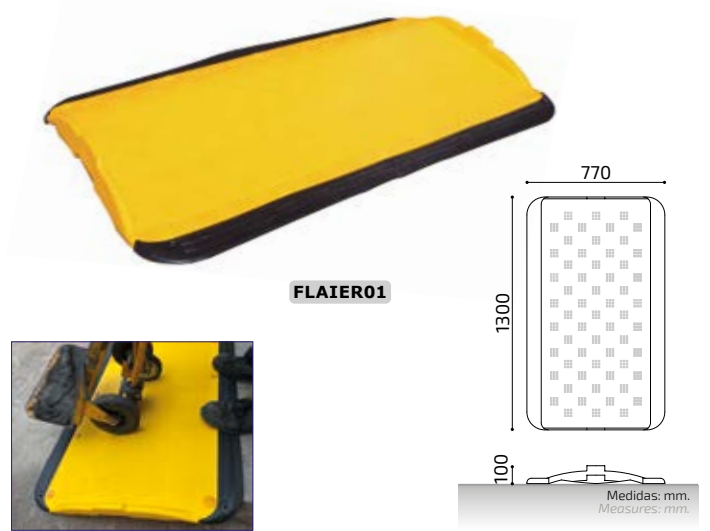

Protector cables | Cable protector

PROLINE

CAUCHO | RUBBER

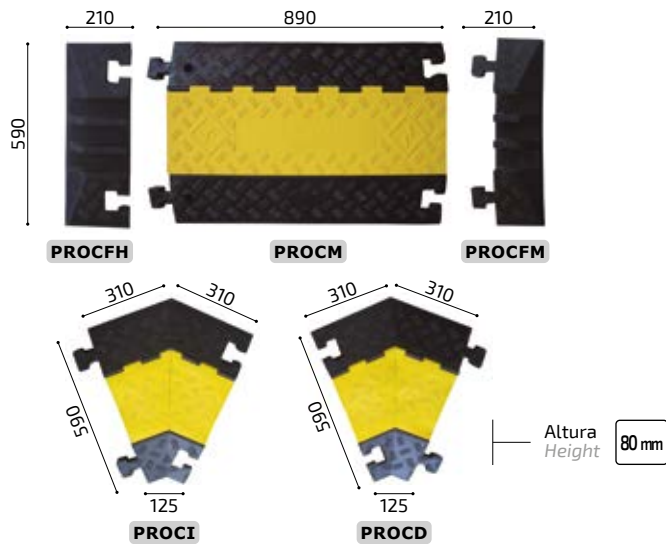

Protector cables | Cable protector

PROMARK

CAUCHO | RUBBER

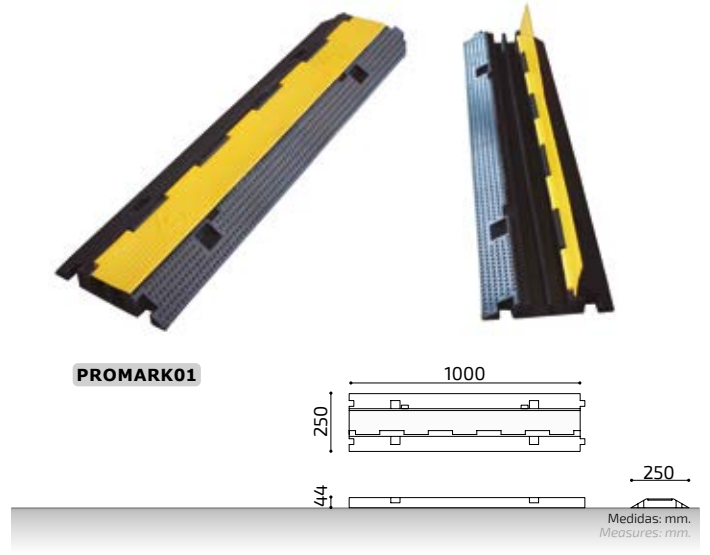

Protector cables | Cable protector

PROCABLE

PLÁSTICO | PLASTIC

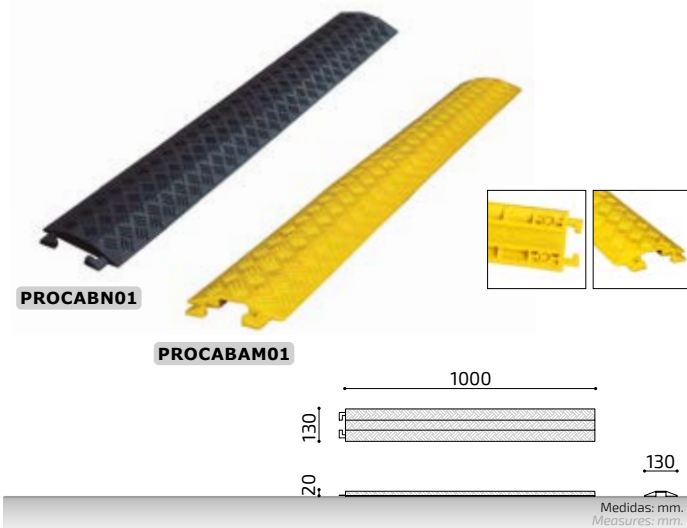

Protector cables | Cable protector

PROWIRE

PLÁSTICO | PLASTIC

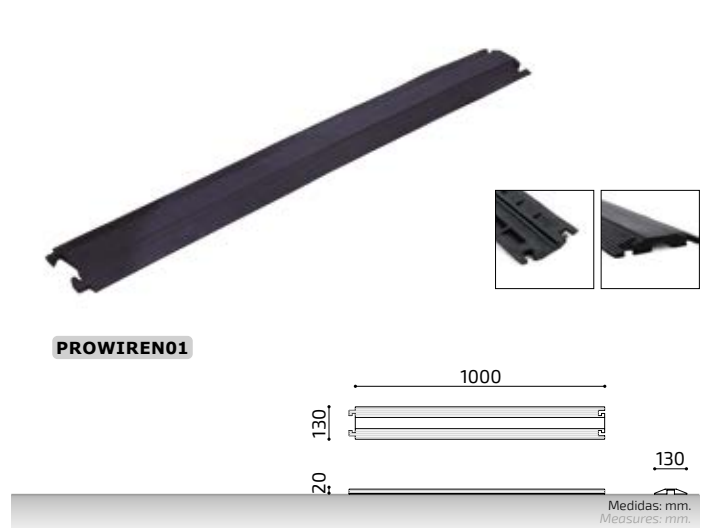

CINTAS SEÑALIZACIÓN SIGNALIZATION TAPES

PLÁSTICO | PLASTIC



CINTAS ANTIDESLIZANTES ANTI-SLIP TAPES

PLÁSTICO | PLASTIC



CINTAS REFLECTANTES REFLECTIVE TAPES

PLÁSTICO | PLASTIC



Dispensador de gel | Gel dispenser

BOLLARD

HIERRO GALVANIZADO + INOX. | GALVANIZED IRON + STAINLESS STEEL



Loseta parques infantiles | Playground flooring

PAFLO

CAUCHO | RUBBER

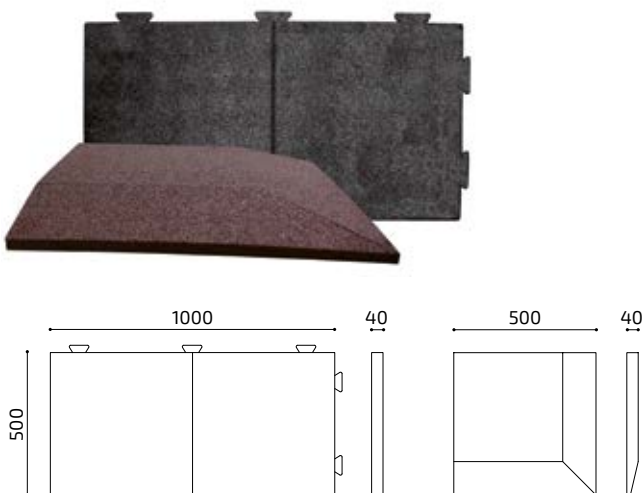

Sacos de caucho y resina para pavimento

Rubber playground and resin flooring

CAUCHO | RUBBER



DOG STOP

ACERO INOXIDABLE | STAINLESS STEEL



DOGSTOPI01

DOGSTOPI02

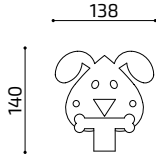
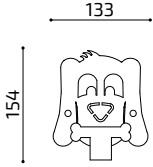

DOG PARK

ALUMINIO + ACERO INOXIDABLE | ALUMINIUM + STAINLESS STEEL



DOGPARKA

DOGPARKV

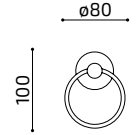
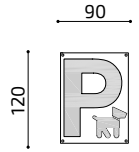

Protectores impactos | Impact protectors PAC / PAF / PAL

ESPUMA | FOAM



PACRB01

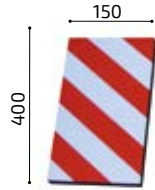

PALRB02



PAFAMN01



PALAMN01

Protectores impactos | Impact protectors PAG / BOAG

ESPUMA | FOAM

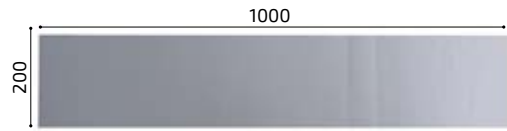

BOAG01

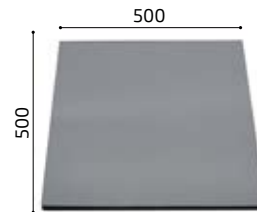

PAG

Protector impactos | Impact protector MAXI

ESPUMA | FOAM



MAXIAMN01

Medidas / Measures

25 m. x 700 mm.

10 m. x 700 mm.

5 m. x 700 mm.

Colores / Colors



Protector impactos | Impact protector IMPACT

PLÁSTICO | PLASTIC



PCA



PARKLETS PLATAFORMAS URBANAS / PARKLETS URBAN PLATFORMS

MADERA • HORMIGÓN • HIERRO GALVANIZADO | WOOD • CONCRETE • GALVANIZED IRON



Plataformas modulares que extienden temporalmente la acera y transforman el espacio de estacionamiento, es una estrategia rápida y económica para proveer de mayor espacio a las ciudades, transformando los estacionamientos en pequeños parques públicos, extensiones de comercios, bares y restaurantes, salidas de colegios, ...

El objetivo principal es reimaginar el espacio público, transformando las calles en espacios de interacción social y fomento del comercio.

Modular platforms that temporarily extend the sidewalk and transform the parking space, is a quick and economic strategy that provides more space, by transforming parking lots into small public parks, shop, bars and restaurants extensions, space out of school, ... The main objective is to reimagine the public space, by transforming the streets into spaces for social interaction and commerce development.



La transformación de espacios de estacionamiento en extensiones de bares y restaurantes es una estrategia clave para la reactivación económica en muchas ciudades.

The transformation of parking lots into bars and restaurants extensions has been a strategy key for economic reactivation in many cities.

Gran variedad de combinaciones pudiendo elegir diferentes tipos de barandillas, jardineras, pavimentos,...

Wide variety of combinations, being able to choose different types of railings, planters, pavement,...



Protección / Protection



Barandillas
Railings



Jardineras
Planters

Pavimento / Pavement



Madera
Wood



Tapa con resaltes
Lid with projections

Rampa acceso abatible
Hinged access ramp



Múltiples combinaciones y medidas.

Lots of measures and combinations.



Fácil manipulación, montaje y reubicación de los módulos mediante transpalet.

Easy handling, assembly and relocation of the modules by using a pallet truck.



Espacio de dos plazas de estacionamiento = 1 parklet

Two parking lots space = 1 parklet.



Dos plazas estacionamiento son ocupadas por 40 vehículos al día.

Two parking lots are occupied by 40 cars a day.



1 parklet beneficia a 300 personas al día.

1 parklet benefits 300 people a dayspace = 1 parklet.

RAMPA ACCESOS ABATIBLE / HINGED ACCESS RAMP

HIERRO GALVANIZADO | GALVANIZED IRON



Rampa accesos abatible para extensiones de aceras, parada autobus y carril bici sobreelevadas.
Hinged access ramp for sidewalks extensión, bus stop and bike lane.



COMPLEMENTOS DEPORTIVOS / SPORTS EQUIPMENT

HIERRO • HIERRO GALVANIZADO | IRON • GALVANIZED IRON



GÁLIBO / MAX. HEADROOM

HIERRO | IRON



 Posibilidad de iluminación con led fijo o intermitente color rojo o blanco. / Possibility of fixed or flashing LED lighting, red or white coloured.



MOBILIARIO COMERCIAL INTERIORISMO

COMMERCIAL FURNITURE
INTERIOR DESIGN

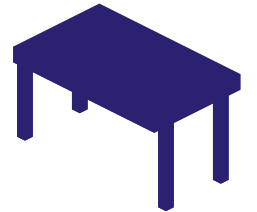

MOBILIARIO / FURNITURE

MADERA • HIERRO • INOX. | WOOD • IRON • STAINLESS STEEL



EXPOSITORES / DISPLAY CASE

MADERA • HIERRO • INOX. | WOOD • IRON • STAINLESS STEEL



VARIOS / OTHER PRODUCTS

MADERA • HIERRO • ACERO INOX. | WOOD • IRON • STAINLESS STEEL



MESAS / TABLES

MADERA • HIERRO • ACERO INOX. | WOOD • IRON • STAINLESS STEEL





Escanear código QR ver en web / Scan the QR code to see on web



Ver todos los modelos en la web / See all models on the web



VALLADOS

FENCES

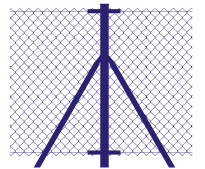

**SIMPLE TORSIÓN
ST FENCE**



**VERJA STIL
STIL FENCE**



**VERJA MALLAZO
ELECTRO WELDED MESH**



**VALLADO RELIGA
GRATING FENCE**



**VARIOS
VARIOUS**





Escanear código QR ver en web / Scan the QR code to see on web



Ver todos los modelos en la web / See all models on the web



CERRAJERÍA

LOCKSMITHING



**BARANDILLAS
RAILINGS**



**ESCALERAS
STAIRS**



**PUERTAS
DOORS**



**MARQUESINAS
CANOPY**



**VARIOS
VARIOUS**





Escanear código QR ver en web / Scan the QR code to see on web



Ver todos los modelos en la web / See all models on the web



ALUMINIO

ALUMINIUM



**VENTANAS
WINDOWS**



**CERRAMIENTOS
ENCLOSURES**

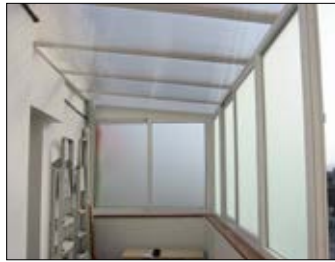

**PUERTAS
DOORS**



**VARIOS
VARIOUS**





Escanear código QR ver en web / Scan the QR code to see on web



Ver todos los modelos en la web / See all models on the web



AUTOMATISMOS

AUTOMATION

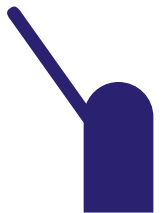

**BARRERAS
BARRIERS**



**PORTILLOS
TURNSTILE**



**MOTORES PUERTAS
MOTORS FOR GATES**



**SISTEMAS APERTURA
OPENING SYSTEMS**



**ELEMENTOS SEGURIDAD
SAFETY SYSTEMS**



**VARIOS
VARIOUS**



CONDICIONES GENERALES DE VENTA

1.- Validez de las presentes condiciones generales de venta.

Las presentes condiciones generales de venta suplantán las anteriores y se aplican a todos los pedidos relativos a los productos de Ado Cerramientos Metálicos, S.A. / Ado Urban Furniture, S.L. (en adelante: ADO). Las siguientes condiciones generales de venta rigen todas las ventas de ADO a los Clientes y constituyen parte integrante del contrato de venta, sustituyendo y anulando toda cláusula o pacto en contrario que figure en el pedido o en otro documento del Cliente. Las informaciones indicadas en los catálogos y demás material informativo tienen un valor puramente indicativo y pueden ser modificadas en cualquier momento por ADO.

2.- Pedidos.

Todos los pedidos se entienden "salvo disponibilidad y modificación de listas de precios". ADO se reserva la facultad de aceptar o rechazar, total o parcialmente, los pedidos del Cliente según su conformidad respecto de las presentes condiciones generales y de la disponibilidad de los productos pedidos. ADO se reserva el derecho de efectuar en cualquier momento modificaciones técnicas a los productos del catálogo, sin que por eso el Cliente pueda esgrimir ninguna pretensión. El Cliente no podrá anular total o parcialmente los pedidos transcurridos 10 días de su envío a ADO; en caso de anulación superado dicho plazo, ADO tendrá derecho a la indemnización por el importe íntegro. En caso de montaje incluido, sí por causas ajenas a ADO no pudiera realizarse el mismo, se facturarán los trabajos a excepción del montaje. No se incluyen trabajos como cualquier obra de albañilería, colocación de andamios, peonaje, personal auxiliar, electricistas, acometidas eléctricas, pintura, descarga, movimiento de materiales en obra, permiso de obra, desmontaje de puertas viejas en obra, retirada de las mismas y escombros, y cualquier otro trabajo no especificado en la oferta. Toda documentación que necesite el comprador, de carácter administrativo o certificado de materiales, deberá ser solicitado a la firma y aceptación de la oferta, nunca después del suministro del material o tras la finalización de los trabajos. Todo pedido enviado por el cliente quedará pendiente de aceptación por nuestro departamento de riesgos quien en última instancia podrá aceptar o no por los informes obtenidos del cliente, no pudiendo por ello reclamar indemnización alguna por el retraso ocasionado en la obtención de los informes pertinentes.

3.- Precios.

ADO vende los productos al cliente a los precios ofertados con entrega franco fábrica salvo acuerdo en contrario por escrito con ADO.

4.- Plazos de entrega.

Todos los productos se entregan franco fábrica, establecimiento de ADO, Badalona, Barcelona. La obligación de entregar la mercancía se cumple con su entrega a la compañía de transportes en los casos que se pacte dicho servicio quedando exonerada de la obligación de entrega de la mercancía en todas las hipótesis de caso fortuito o fuerza mayor, huelgas o imposibilidad de abastecimiento de las materias primas u otra indisponibilidad de los productos.

5.- Envíos.

La mercancía viaja siempre por cuenta y riesgo del cliente. Los posibles robos, sustracciones, pérdidas, deterioro o falta de mercancía no eximen al cliente de la obligación de pago del precio, siempre que la mercancía haya sido entregada regularmente al transportista en el establecimiento de ADO. La mercancía no está cubierta por póliza de seguro, salvo pedido expreso del cliente y por su cuenta y riesgo.

6.- Recogida de la mercancía.

El cliente se obliga a recoger la mercancía tan pronto como reciba el aviso de puesta a disposición. De retrasarse, ADO tendrá el derecho (además de percibir el pago del precio íntegro) de pedir el reembolso de los gastos de almacenamiento y de custodia de la mercancía, sin perjuicio de la posible indemnización por daños. ADO no responde de los daños, directos o indirectos, que pudieran surgir a causa del depósito de la mercancía no retirada o retirada con retraso tanto en los almacenes de ADO como en aquellos de la compañía de transportes o demás.

7.- Garantía.

ADO garantiza sus productos, de marca ADO contra los defectos de materiales o de fabricación según las condiciones y los límites de instalación y de utilización indicados por ADO. ADO no se considerará responsable si los productos se conectan, asocian o interconectan con otros productos no entregados por ADO. El cliente deberá instalar los productos ADO solamente asociados con otros productos ADO. En caso contrario la garantía caducará. ADO no es responsable si no se respetan las instrucciones de montaje y de utilización o las normativas eléctricas u otras especificaciones vigentes en el momento de la instalación, ni tampoco si los accesorios y componentes eléctricos o mecánicos de ADO se instalan, utilizan o conectan sin respetar los esquemas y los tipos de conexiones para los que han sido concebidos. Igualmente ADO no se considerará responsable por empleo o aplicación de los productos para finalidades no adecuadas para el tipo, capacidad y alcance los productos ADO. Para los productos que no estén más amparados por garantía, ADO suministra un servicio de asistencia para la reparación de los equipos, cargando en cuenta los gastos correspondientes. Para los equipos que no puedan repararse, ADO, según su juicio indiscutible, podrá sustituirlos cargando el precio correspondiente al cliente. Los portes de envío o recogida al servicio posventa siempre son a cargo del cliente y en ningún caso a cuenta de ADO, pudiendo éste utilizar cualquier agencia de transporte para realizar el envío o recogida de la mercancía.

8.- Reclamaciones y responsabilidad.

ADO declina toda responsabilidad sobre las faltas, deterioros, posibles robos o hurtos de la mercancía una vez entregada al cliente. ADO se reserva el derecho de aceptar o no las devoluciones del material suministrado, cuando así lo solicite el cliente, y siempre y cuando el material se encuentre en perfecto estado y no haya quedado descatalogado, siendo a cargo del cliente los gastos de manipulación. Toda reclamación por el material suministrado se deberá comunicar en un periodo máximo de 48 horas desde la recepción de la mercancía. Ninguna reclamación puede dar derecho a la demora o a la suspensión de los plazos de pago, debiéndose pagar por entero la parte no contestada.

9.- Reserva de dominio.

La mercancía vendida es de propiedad de ADO hasta su pago completo. Por consiguiente, hasta que se realice al pago íntegro del precio por el capital y accesorios, las mercancías entregadas, dondequiera que se encuentren e incluso si ya fueron revendidas por el cliente, siguen siendo de propiedad exclusiva de ADO. Los cheques, letras y cesiones de crédito no se considerarán como pagos hasta el momento del cobro efectivo. Si los productos no fueran pagados, ADO podrá tomar nuevamente posición de los productos vendidos dondequiera que estos se encuentren. El cliente está obligado a comunicar el nombre de los terceros que hayan comprado los productos y ante los que ADO tendrá el derecho de reivindicar sus derechos y de retirar los productos.

10.- Condiciones de pago.

Todos los pagos deberán efectuarse exclusivamente a ADO dentro de los plazos y siguiendo las pautas indicadas en la factura y siempre conforme a la nueva ley de 7 de julio de 2010 Ley 15/2010 de lucha contra la morosidad en las operaciones comerciales. FACULTAD DE RESOLUCIÓN Y SUSPENSIÓN DE LA EJECUCIÓN: de demorarse el pago tan solo de una cuota y de los plazos estipulados, ADO se reserva la facultad de suspender – incluso sin previo aviso- la ejecución/entrega del pedido, o de renunciar a posibles contratos en curso, aunque sean otros no afectados por la mora, sin que el cliente tenga derecho a solicitar ninguna clase de indemnización. El retraso en los pagos dentro de los plazos estipulados también facultará a ADO a subordinar las demás entregas al pago íntegro del importe vencido con los intereses correspondientes, y de otros importes a cobrar, por que el cliente pierde el beneficio de la posibilidad de pagar a plazos los importes sucesivos, o bien deberá presentar contemporáneamente unas garantías adecuadas. COMPENSACIÓN: No se admite, salvo aceptación en contrario por escrito, ninguna compensación entre posibles créditos del cliente con ADO y las deudas del cliente, bajo cualquier concepto, que deriven, sean inherentes o consiguientes al contrato de venta.

11.- Patentes, marcas y elementos de identificación.

El cliente sabe que los productos ADO están amparados por patente y son Know-How y diseño de propiedad industrial exclusiva de ADO. El cliente tiene prohibido violar dichos derechos de ADO y quitar, eliminar o alterar de modo alguno las marcas y otros elementos de identificación o siglas de cualquier tipo aplicadas en los productos de ADO, está prohibida la reproducción bajo cualquier forma o la utilización de la marca ADO y de cualquier otro elemento de identificación presente en los productos.

12.- Clausula resolutoria.

En caso de falta de pago, la venta podrá cancelarse de pleno derecho en cualquier momento, mediante una simple comunicación por escrito enviada por ADO al cliente en la que se indique que recurre a la presente cláusula y sin necesidad de ninguna formalidad judicial. Las mercancías entregadas y no pagadas deberán devolverse a ADO a costas del cliente. A tal fin ADO y los transportistas encargados estarán autorizados a rescindir y recoger la mercancía no pagada de los locales de los clientes.

13.- Ley española y fuero competente.

Para cualquier controversia que surja en la ejecución del contrato las partes acuerdan la aplicación de la ley española, y se someten a la jurisdicción exclusiva de los juzgados y tribunales de Badalona, con renuncia a su propio fuero.

GENERAL SALES CONDITIONS

1.- General sales conditions validity.

This General sales conditions supersedes the previous one and will be applied to all product orders of Ado Cerramientos Metálicos, S.A. / Ado Urban Furniture, S.L. (hereinafter: ADO). The following General sales conditions governs all ADO's sales to the Customer/Buyer. It is part of the sales contract and supersedes any contrary term or agreement in the order or in any other Customer's documents. Information contained in catalogues or any advertising material is merely indicative and can be changed at any time by ADO.

2.- Orders.

All orders are subject to "availability and price list changes." ADO reserves the right to accept or reject all or part of Customer's orders, according to their conformity to the general conditions and the products availability. ADO also reserves the right to make technical changes to any product, at any time. The Buyer cannot cancel orders entirely or in part after 10 days from sent date; in case of cancellation beyond this deadline, ADO will be entitled to compensation for the full amount. When installation is included, if it couldn't be done for reasons beyond ADO's control, works will be billed but not the installation. Works of masonry, scaffolding installation, support staff, electricians, electrical connections, painting, unloading, materials movements on site, building permission, old doors removal on site, debris removal or any other work not specified in the Offer will not be included. All documentation required by the Customer either administrative or material certificates, must be requested before the Offer acceptance, never after the material supply or after work termination. Any order sent by the Customer is subjected to acceptance by our Risk Department which can accept or reject the order according to the Customer report. Therefore, the Customer cannot claim compensation for the delay caused in obtaining this report.

3.- Prices.

ADO sells products to Customers at the offered prices with delivery in our factory, unless otherwise stated in a written agreement between ADO and the Buyer.

4.- Delivery.

All products are delivered in our factory, establishment of ADO, Badalona, Barcelona. The obligation to deliver the goods is met with their delivery to the transportation company, in case this service is agreed on. ADO is relieved of the obligation to deliver the goods in all scenarios of unforeseeable circumstances or force majeure, strikes, or failure to supply raw materials or other product unavailability.

5.- Shipments.

The goods travel at the risks and danger of the Buyer. Possible loss, theft or damage of the goods will not relieve the Buyer from his obligation to pay for the goods, as long as ADO has successfully delivered the goods to the transport company in the establishment of ADO. Goods are not covered by insurance policy, unless the Buyer expressly asked for it, at his expenses.

6.- Goods collection.

The Buyer is obliged to collect the goods as soon as he receives the availability notice. In case of delay in doing so, ADO has the right (in addition to be entitled to full payment of the price) to request reimbursement of storage and custody costs of the goods, without prejudice to the possibility to claim damages. ADO is not responsible for any damages, direct or indirect, that may arise due to the deposit of goods not collected or collected with delay in ADO's stores as in those of the transportation company.

7.- Guarantee.

ADO guarantees its products, branded "ADO", against defects in materials and workmanship under installation, use conditions and limits set by ADO. ADO will not be held liable if the products are connected, associated or interconnected with other products not delivered by ADO. The Buyer must install only ADO products associated with other ADO products. If not, the warranty expires.

ADO is not responsible if use and mounting instructions as well as electrical codes or other specifications in effect at the time of installation are not correctly followed, or whether the accessories, the electrical and mechanical components of ADO are installed, used or connected without regard to schemes and to the types of connections for which they were intended. Also, ADO will not be held liable for use or application of products for purposes not appropriate for the type, capacity and product range of ADO. For more products not covered by warranty, ADO provides a support service for the repair of equipment, for which the Buyer will be charged.

For products that cannot be repaired, ADO, at its discretion without question, can replace the corresponding price charged to the Buyer. All the costs connected to shipping or picking up of the goods are at the Buyer's expense. ADO will never bear any transportation costs and reserves the right to collaborate with any transportation company to carry out the shipping or pickup of merchandise.

8.- Complaints and liability.

ADO assumes no responsibility for errors, damages, or theft after delivery to the Buyer. ADO reserves the right to accept or not the returns of the material supplied, when requested by the Buyer. Provided that the material is in perfect condition and has not been discontinued, the Buyer will be charged to the costs of handling. Any claim for the material provided shall be notified within a maximum period of 48 hours from receipt of goods. No claim may entitle the Buyer to delay or suspend the payment terms.

9.- Retention of title.

The merchandise sold is owned by ADO until full payment. Therefore, until full payment is made to the price of capital and accessories, the goods delivered, wherever they are and even if they were resold by the Buyer, remain sole and exclusive property of ADO. Checks, bills and granting of credits do not constitute payment until the time of actual receipt. If products were not paid, ADO may take new position of sales, wherever the products are. The Buyer is obliged to report the names of the parties who have purchased the products and ADO will be entitled to claim rights and to withdraw the products.

10.- Payment Terms.

All payments must be made exclusively to ADO, within the time limits and according to the guidelines set in the invoice, always in accordance with the new law of July 7, 2010 Law 15/2010 on Measures against late payment in commercial transactions. FACULTY RESOLUTIONS AND SUSPENSION OF EXECUTION: the delay of even just one payment entitles ADO to the right to suspend - even without prior notice- the implementation / delivery order as well as to waive any contract in progress, even if the other orders are not affected by the delay, without the Buyer being entitled to seek compensation of any sort. The delay in payments within the stipulated time frame also entitles ADO to subordinate other deliveries to the full payment of the due amount with interest and other amounts receivable, because the Buyer loses the benefit of the possibility to pay the future amounts by instalments, unless he can provide credible assurances and financial guarantees. COMPENSATION: not supported, unless otherwise stated in writing. Under no circumstances there will be compensation from ADO for any Buyer's credits and debts arising, whether incidental or consequential, from the sales contract.

11.- Patents, trademarks and identifying elements.

The Buyer knows that ADO products are protected by patents, know-how and industrial property design, exclusive of ADO. The Buyer cannot violate those rights removing, deleting or altering in any way the brand or other identification or initials in any ADO products. Reproduction in any form or use of the mark ADO or of any other identifying element present in the products is strictly forbidden.

12.- Termination clause.

In case of non-payment, the sale may be cancelled at any time by a simple written communication sent by ADO to the Buyer, enforcing this clause without any further legal formality. Goods delivered and not paid shall be returned to ADO at the expense of the Buyer. To this end, ADO and the transportation company will be entitled to terminate the contract and collect the unpaid merchandise from the Buyer's premises.

13.- Spanish law and jurisdiction.

For any dispute arising in the execution of the contract the parties agree to the application of Spanish law, and submit to the exclusive jurisdiction of the Courts of Badalona, waiving their own jurisdiction.

